

# CHEONMUN

ACE FIRE DOOR

INTERIOR STEEL DOOR ACE WILL APPROACH TOWARD THE PUBLIC WITH GOOD DESIGN AND UNIQUE PRODUCT. ACE WILL NOT STAY STILL, BUT DEVELOP PERSISTENTLY AND DO ITS BEST. VERY SMALL DEIFFERENCES IN THE ATMOSPHERE OF THE HOUSE.



카카오톡 채널 QR

**에이스산업**  
**에이스 (주)천문**

<http://acefiredoor.co.kr>

본사 경기도 화성시 황계남길 123번길 1(황계동 109번지)  
수원공장 TEL. (031) 225-6693  
FAX. (031) 224-6693  
평택공장 경기도 평택시 고덕면 청원로 732-6(동청리 153번지)  
TEL. (031) 668-6693  
FAX. (031) 611-6693  
E-mail ace6693@daum.net

기획·제작 | 다미인문 (02)933-1588(대)

# CHEONMUN

ACE FIRE DOOR



INTERIOR STEEL  
DOOR BEST  
COLLECTION

N.09



(주)천문 | 에이스산업

# High Quality Best collection

90's

- 1988 만물 셔터 방화문 창업
- 1992.02 화성시 진안동 확장 이전
- 1994 에이스 방화문 상호 변경
- 1999.04 자동화라인 설치
- 1999.04 ACE 브랜드 제품 출시
- 1999.10 IOS 9001,9002 인증서 획득(품질 경영 인증 시스템)

2012

- 2012.05 화성시 황계동 확장 이전
- 2012.10 ㈜ 천문 설립

2015

- 2015.08 공장등록 (분류번호: 25111/금속문, 창, 셔터 및 관련제품 제조)
- 2015.10 대표이사 장경근 취임

2016

- 2015.12 특허등록 (공통출원) (등록번호 제 10-1000721호)
- 2016.05 벤처기업 등록 (제 20160105867호)
- 2016.08 디자인 등록 (등록번호 제 30-0867855호)
- 2016.08 상표 등록 (등록번호 제 40-1194748호)
- 2016.09 ISO 9001 인증 (인증품목: 방화문)
- 2016.11 경기 가족친화 일하기 좋은기업 선정 (경기도)
- 2016.12 병역특례지정업체 선정 (병무청)
- 2016.12 기업 부설연구소 인정 (한국산업기술진흥협회)
- 2016.12 KS 인증(인증기관 : 한국건설생활환경시험연구원)
- 2016.12 KS인증 취득 (표준명: 문세트 / 표준번호: KS F 3109 / 품목: 강철제문, 방화문)

2017

- 2017.01 제 2공장 준공 (경기도 평택공장 고덕면 동청리 153번지)

2018

- 2017.01 「건,품질인증 취득 (인증기관 : 한국건설생활환경시험연구원)
- 2018.06 경기도 일자리우수기업 선정 (경기도)
- 2018.12 경영혁신형 (MAIN BIZ) 중소기업 「재인증」
- 2018.12 조달청 「물품」 경영인찰 참가자격 등록 (품목 : 방화문)

2019

- 2019.09 ISO 9001 인증 (인증품목: 보통문, 방화문, 단열문)

2021

- 2021.04 문턱없는 철재방화문 내화 성능시험 합격 (KPL21-0151)
- 2021.12 특허 출원 신청 (현장조립용 철재방화문 문틀 외 1건)

2023

- 2023.01 건축자재등 품질 인정서 획득 (품목 구조[편개] 3종)
- 2023.02 KS인증 재취득 (표준명: 문세트 / 표준번호: KS F 3109 / 품목: 방화문, 보통문, 단열문)

2024

- 2023.09 건축자재등 품질 인정서 획득 (품목 구조[양개] 2종)
- 2024.02 건축자재등 품질 인정서 획득 (품목 구조[편개] 2종)

## 대한민국 10대 기업 납품실적

- 삼성 반도체(화성,탕정) 공장 납품
- LG 반도체(파주) 공장 납품
- 포스코 총주 연구 센터 납품
- 효성 TMI 협력업체
- 천안지청, 강남경찰서 신축현장
- 동탄-서린바이오
- 제주 클리프 호텔
- 세종시 포스코 연구단지
- 신세계 여의도 잠사화관 업무시설 신축
- 이마트(죽전, 김포) 신축
- 양지KCC 물류센터
- 충대병원 증축 공사
- 청주 소년원, 의료원
- 충남 테크노파크 현장

## 대학교 납품실적

- 용인대학교 증축공사 현장 납품
- 명지대학교 증축공사 현장 납품
- 아주대학교 증축공사 현장 납품
- 발안 폴리텍대학교 기숙사 현장 납품
- 한신대학교 리모델링 현장
- 수원대학교 리모델링 현장 등 다수 대학교 납품 (초·중·고 다수 납품)

## MBC LOVE HOUSE 협찬

## 태안로타리 사랑의 집짓기 협찬

행복을 열어드립니다.  
꿈을 담아드립니다.

현관문을 여는 순간, 편히 쉴 수 있는 보금자리와 사랑하는 가족이 있습니다. 현관문은 집의 얼굴입니다. 가정의 행복을 열어주는 문, 꿈을 담아드리는 문, 정감 있고 튼튼한 문. "고객감동"을 기본 이념으로 하는 저희 회사는 오늘도 고객님의 요구에 부응하는 다양한 디자인 개발과 더불어 지속적인 기술 개발에 심혈을 기울이고 있습니다.

## CERTIFICATE 인증서



KS 제품인증서

ISO 인증서



ACE FIRE DOOR

International Industrial Certification

## 건축자재등 [방화문] 품질인정 개요

화재 발생 시 건축물의 구조적 안전을 도모하고 화재 확산 및 유독가스 발생 등을 방지하는 등등 인명과 재산을 보호하기 위하여 「건축법」 제 52조의 5 및 제52조의6에 따라 운영하게 되며, '건축자재등 품질인정 및 관리기준'에 따라 제조현장 확인점검 및 품질시험을 통하여 적합한 기업에 인정서를 발급하는 제도입니다.

### [내화구조, 내화채움구조, 방화문, 자동방화셔터, 복합자재 등]

\* 2021년 08월 07일 이후 허가, 신고 된 건축물과 대수선허가를 받은 경우는 반드시 국토교통부의 품질 인정을 받은 방화문으로만 시공해야 합니다.

## Q&A

### 자주묻는 질문

**Q1.**  
품질인정서 발급요청

인정서 발급을 위해서는 발주 전 인정제품으로 제작이 되어야하며, 제품 출하 후 '품질관리서' 작성이 완료된 후에 발급이 가능합니다.

**Q2.**  
품질관리서란?

제조처에서 납품 당시 작성한 품질관리서를 '유통업자 ▶ 공사시공자 ▶ 공사감리자 ▶ 건축주'순서에 따라 사용승인 하여 허가권자에게 제출하는 양식입니다.

**Q3.**  
복합인정제품[내화, 단열, 결로]

인정방화문의 필수성능은 내화시험과 문세트시험 등으로 단열, 결로는 추가 시험을 받은 성적서로 인증이 가능합니다

**Q4.**  
방화문 명칭 개정

갑종방화문[비차열60분 이상 + 차열 30분 이상] ▶ **60분+ 방화문**  
 갑종방화문[비차열60분 이상] ▶ **60분 방화문**  
 을종방화문[비차열30분 이상 ~ 60분 미만] ▶ **30분 방화문**  
 ※ 갑종방화문과 을종방화문이라는 용어는 폐지되어 더 이상 사용하지 않고 있습니다.

## | 인정서

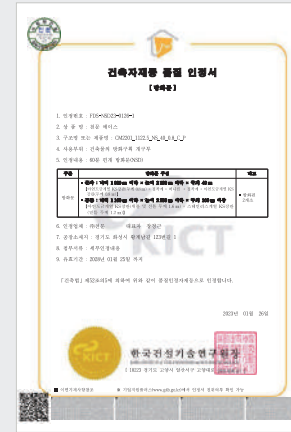

일반방화문 [1100 X 2250]

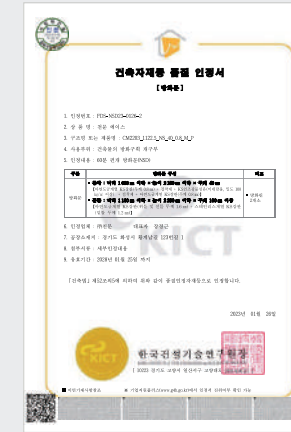

복합인정방화문 [1100 X 2250]

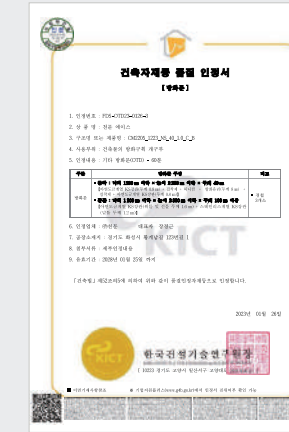

문턱없는 방화문 [1200 X 2300]

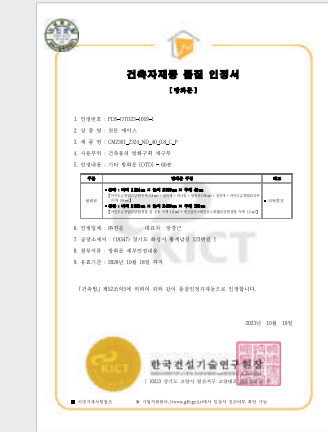

양개 방화문 [2300 X 2400]

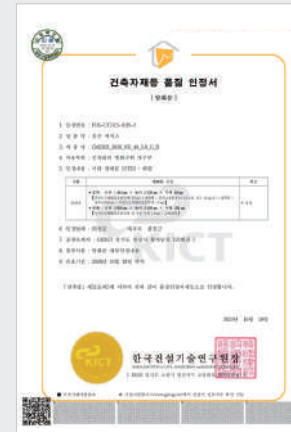

문턱없는 방화문 [3000 X 3000]

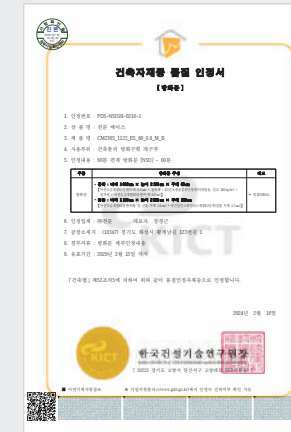

유럽형 단열문 [1100 X 2200]

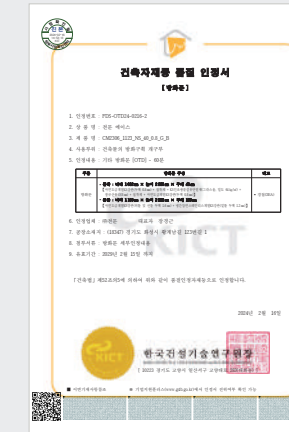

시창 편개 방화문 [1100 X 2300]

## | 인정품목 리스트

순번	규격	요구성능			비고
		내화	단열	시창	
1	1100 X 2250	O	X	X	편개 / 40T 피벗타입 / 하니콤
2	1100 X 2250	O	O	X	편개 / 40T 피벗타입 / 미네랄울
3	1200 X 2300	O	X	O	편개 / 40T / 하니콤 / 문턱없는 방화문
4	2300 X 2400	O	X	O	양개 / 40T 피벗타입 / 하니콤 / 한타
5	3000 X 3000	O	X	O	양개 / 40T / 그라스울 / 한타 / 문턱없는 방화문
6	1100 X 2200	O	O	X	편개 / 60T 유럽형 / 미네랄울
7	1100 X 2300	O	X	O	편개 / 40T 경첩타입 / 그라스울

※ 방화문 인정서 추가 취득 진행중

\* 본 카탈로그에 실린 색상은 인쇄된 것이므로 실제 색상과는 다를 수 있습니다.

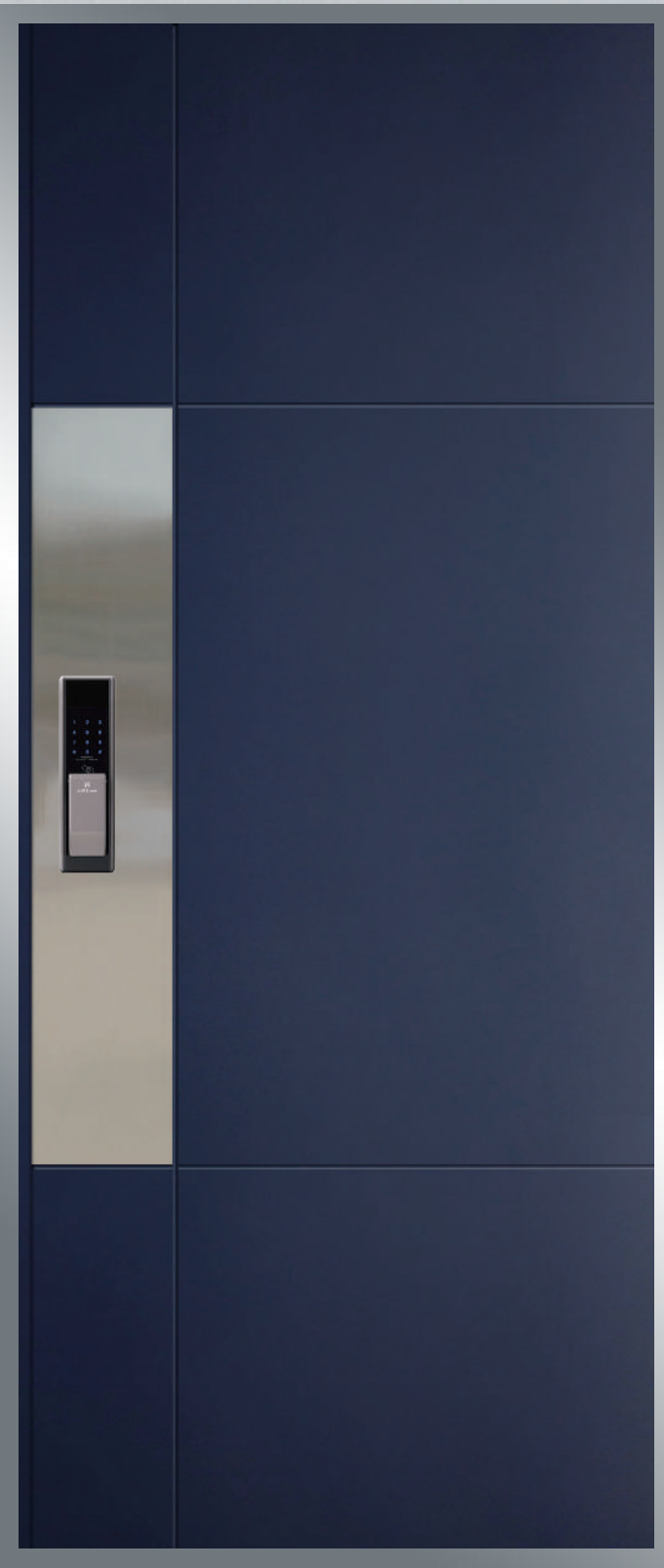

CHM 01



CHM 06 NEW

CHM 07 NEW

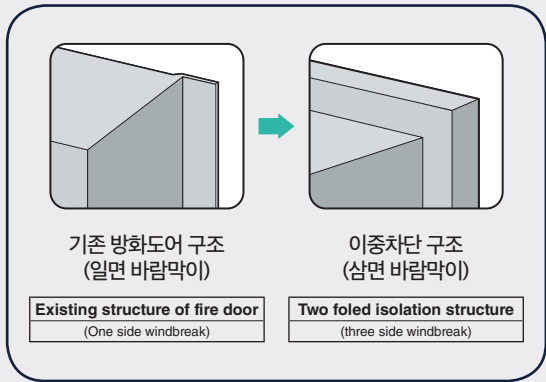
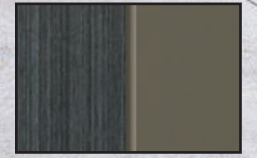

일정 간격의 홈을 내어 공기를 순환시킴으로서  
안과 밖의 온도차를 좁혀 성애와 습기가  
차지 않도록 방지해 줍니다.

By making groove at regular interval and circulating the air, decrease the temperature between the inside and outside to prevent it from the frost and moisture.

HORIZONTAL SECTION

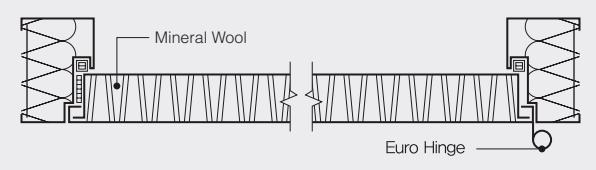

VERTICAL SECTION

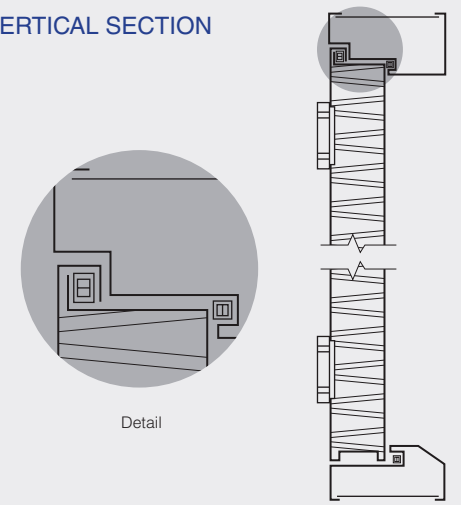

\* 본 카탈로그에 실린 색상은 인쇄된 것이므로 실제 색상과는 다를 수 있습니다.

CHM 02



CHM 03



CHM 04



CHM 05

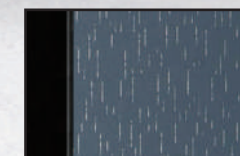

\*색상 변경 가능  
\*51페이지 색상표 참조

\* 본 카탈로그에 실린 색상은 인쇄된 것이므로 실제 색상과는 다를 수 있습니다.

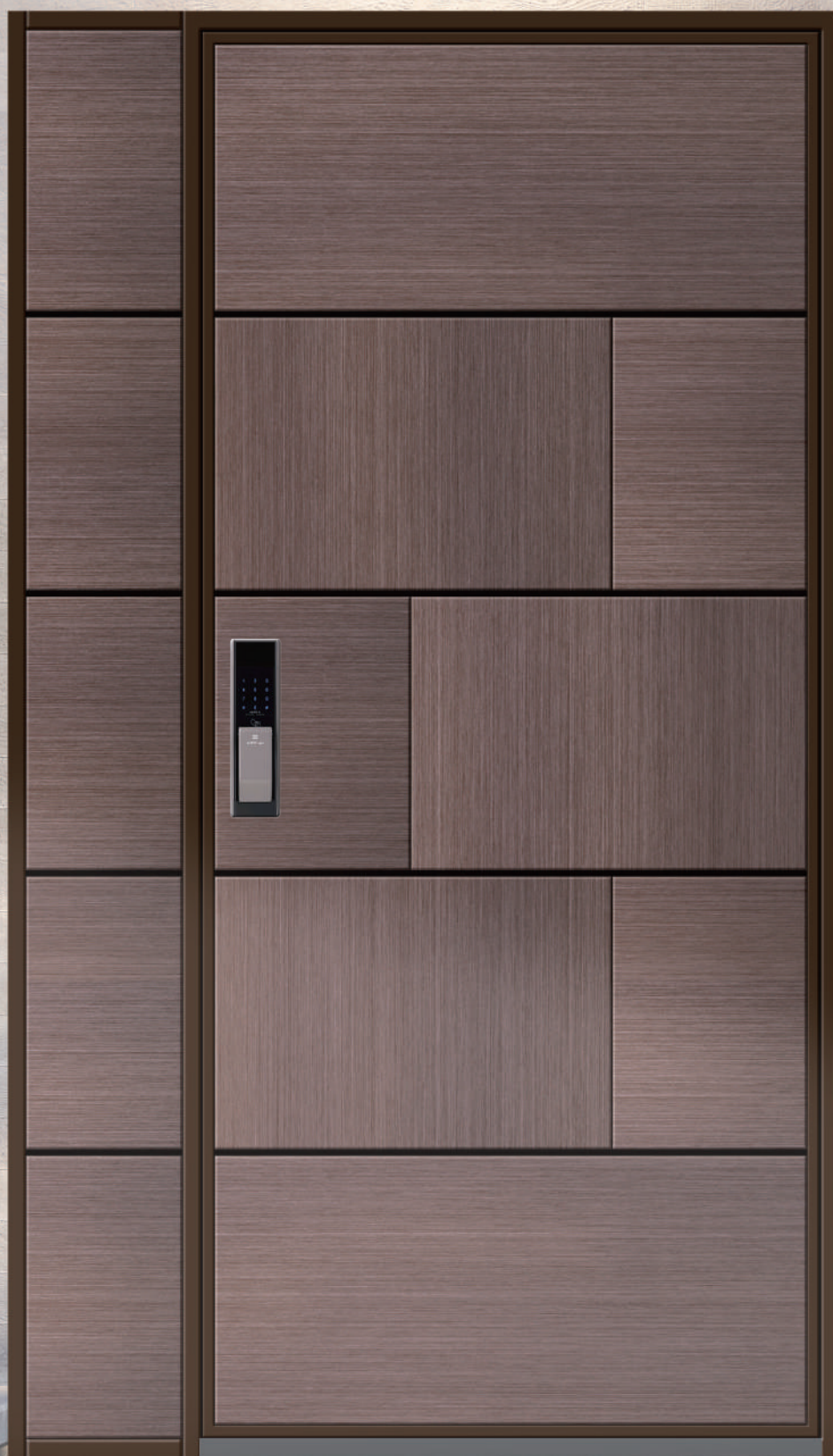

AGD 901

방화, 단열, 방풍에 강한 도시적인 감성이 가득한 디자인, 한눈에 시선을 강렬하게 사로잡는 현대인들의 감성을 잘 반영한 도어입니다.

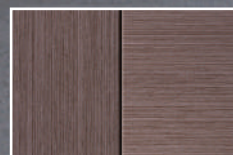

단열, 방화 현관문

AGD 902

STEEL 강판 / 미네랄울 / 사면 2중턱 / 매립힌지 구조  
단열, 방범 기능을 충족한 기능성 현관문

✓ 최상급 사양

- 후렘 : 150mm(egi 1.6t / 단열, 방화소재(미네랄울)충진
- 도어: 72mm(egi 0.8t / 단열, 방화소재(미네랄울)충진
- 매립형 도어 클로저
- 매립형 힌지
- 4면이중턱(유럽형)
- 세미톤 도장
- 전면-스텐발색헤어, 예칭 / 칼라강판 판넬

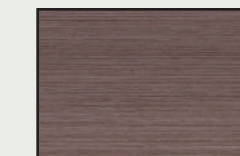

스텐적동발색헤어라인

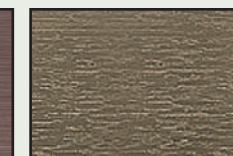

스텐황동발색에칭

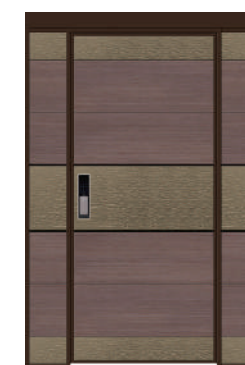

A 타입

단독주택용 \_ 1650×2400



B 타입

단독주택용 \_ 1350×2400



C 타입

주택/고급빌라용 \_ 1350×2250



AD 타입

주택/고급빌라용 \_ 1050×2250

\* 본 카다로그에 실린 색상은 인쇄된 것이므로 실제 색상과는 다를 수 있습니다.



NEW 02

블랙스텐 골드스텐



AGD 102

스텐장식



AGD 103

\* 본 카다로그에 실린 색상은 인쇄된 것이므로 실제 색상과는 다를 수 있습니다.

PREMIUM DOOR

프리미엄 도어

유럽의 감각과 디자인, 기능성 구조, 프리미엄 소재를 적용한 고급 주택용 도어

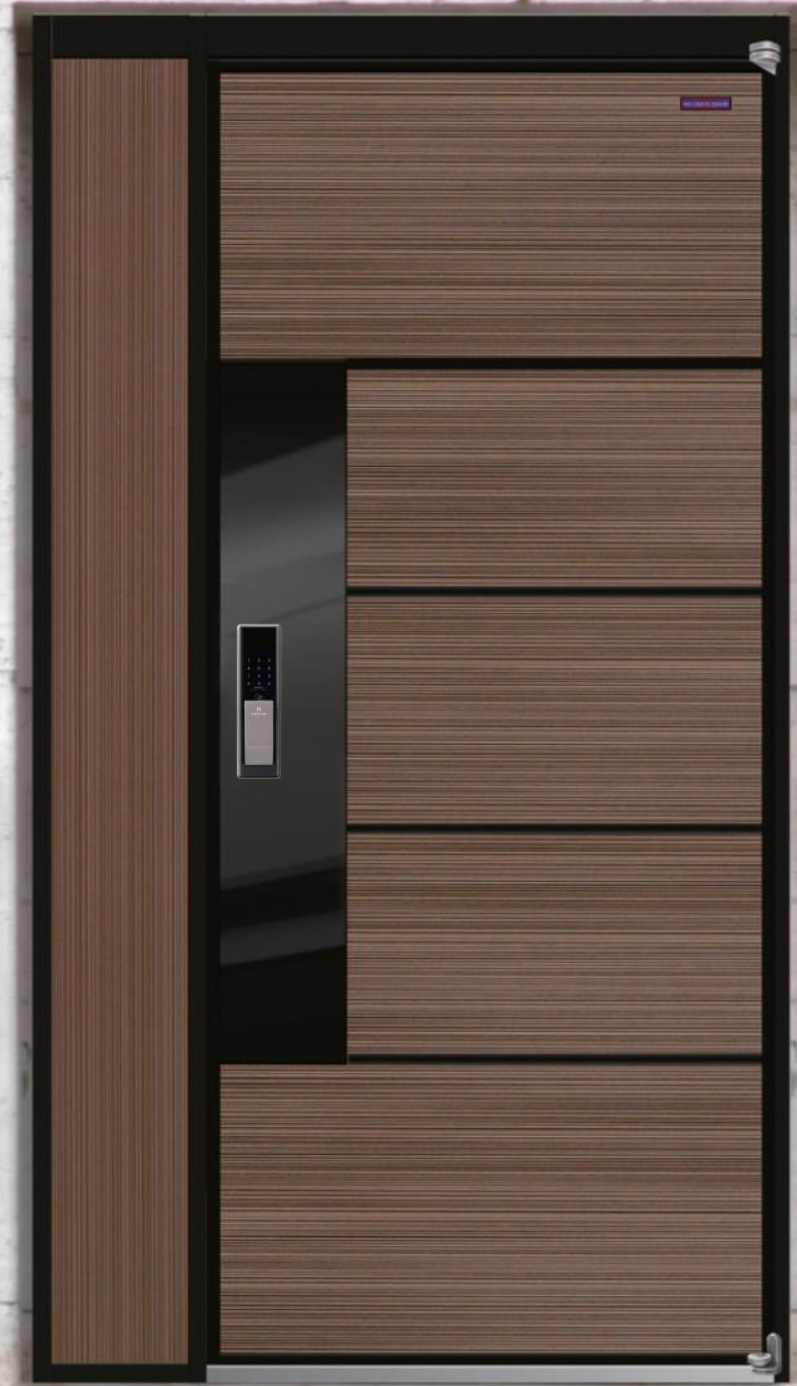

**ASB-01R** **NEW**  
Standard size : 1350×2300×120

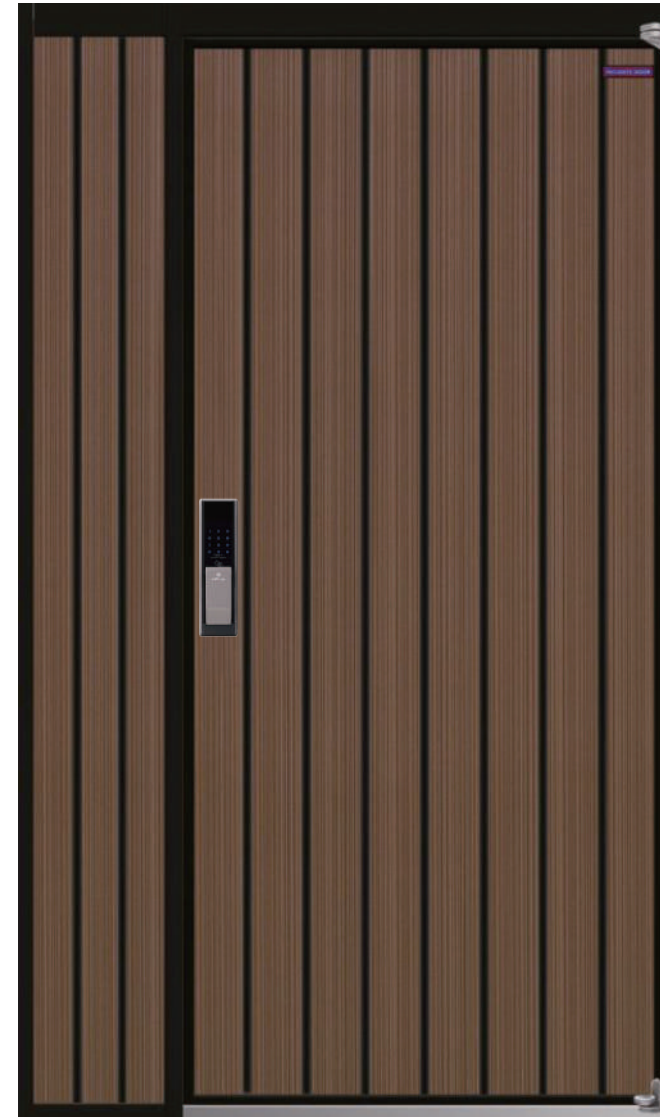

**ASB-02R** **NEW**  
Standard size : 1350×2300×120

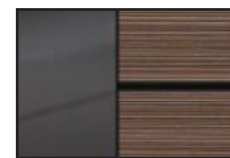

멀티칼라강판  
블랙밀러

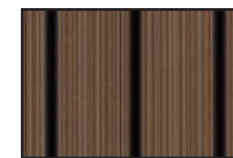

멀티칼라강판



**NEW**  
**ASB-01**  
Standard size :  
1000×2300×120

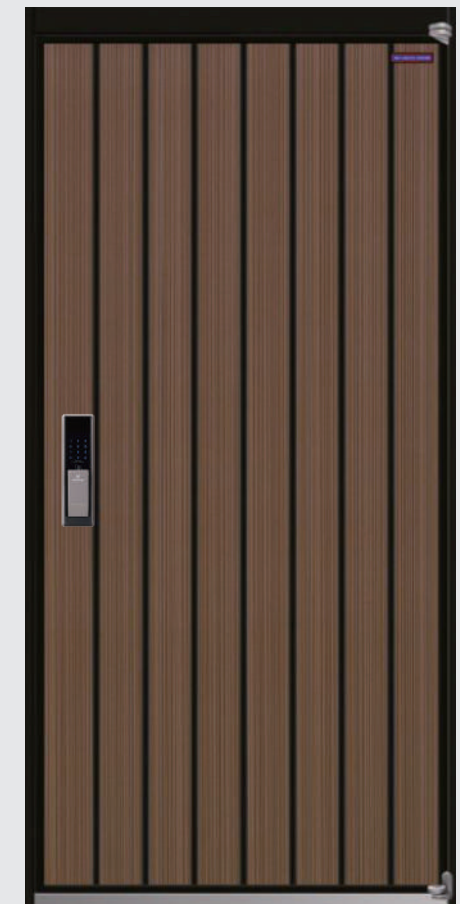

**NEW**  
**ASB-02**  
Standard size:  
1000×2300×120

\* 본 카다로그에 실린 색상은 인쇄된 것이므로 실제 색상과는 다를 수 있습니다.





**ASB-03R** **NEW**  
Standard size : 1350×2300×120

**PREMIUM DOOR**

**프리미엄 도어**

유럽의 감각과 디자인, 기능성 구조, 프리미엄 소재를 적용한 고급 주택용 도어

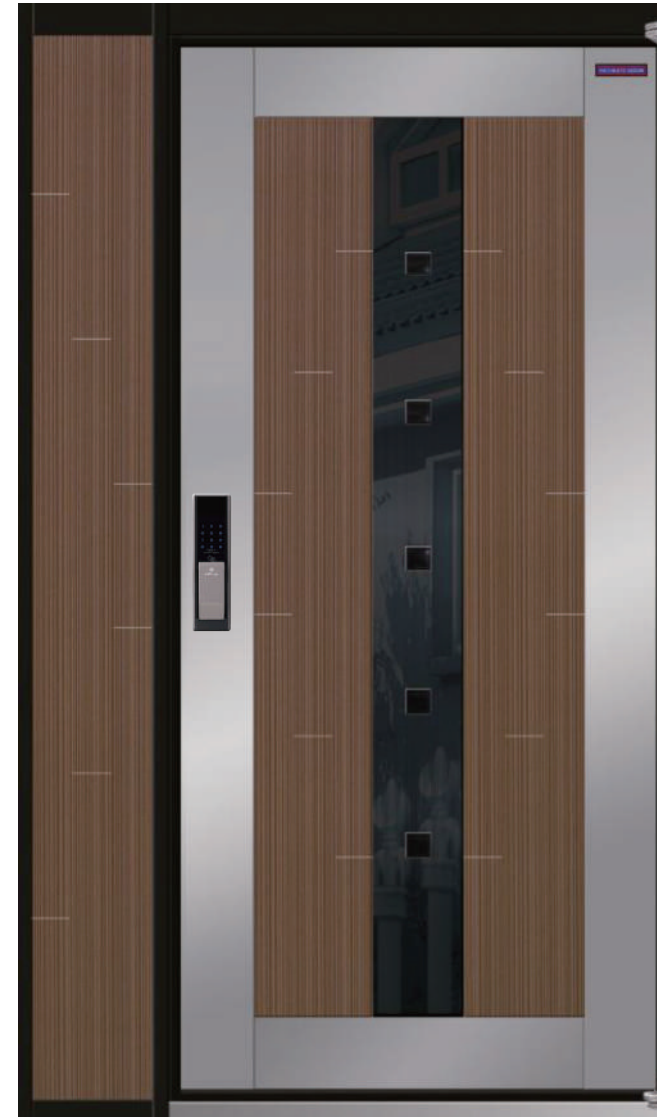

**ASB-04R** **NEW**

Standard size : 1350×2300×120



멀티칼라강판  
비드스텐

멀티칼라강판  
블랙밀러



**NEW**

**ASB-03**

Standard size :  
1000×2300×120

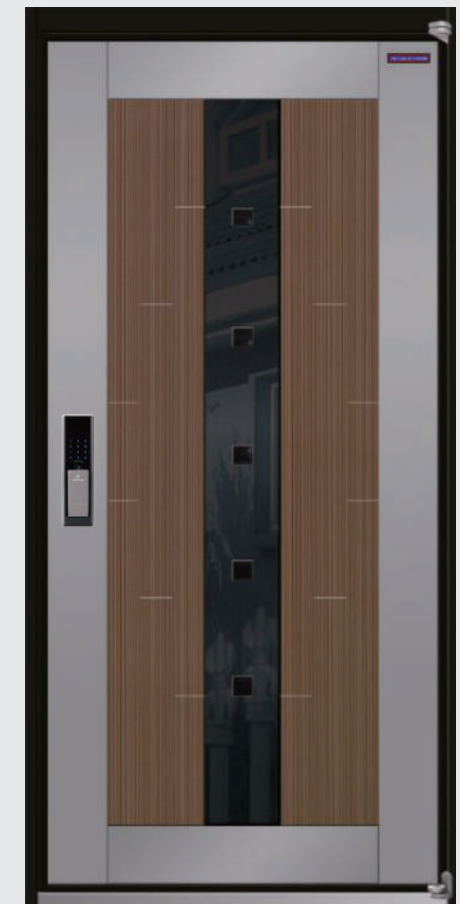

**NEW**

**ASB-04**

Standard size :  
1000×2100×100

\* 본 카다로그에 실린 색상은 인쇄된 것이므로 실제 색상과는 다를 수 있습니다.

현관문 상세도

| 입면 상세도 | 수직 단면 상세도

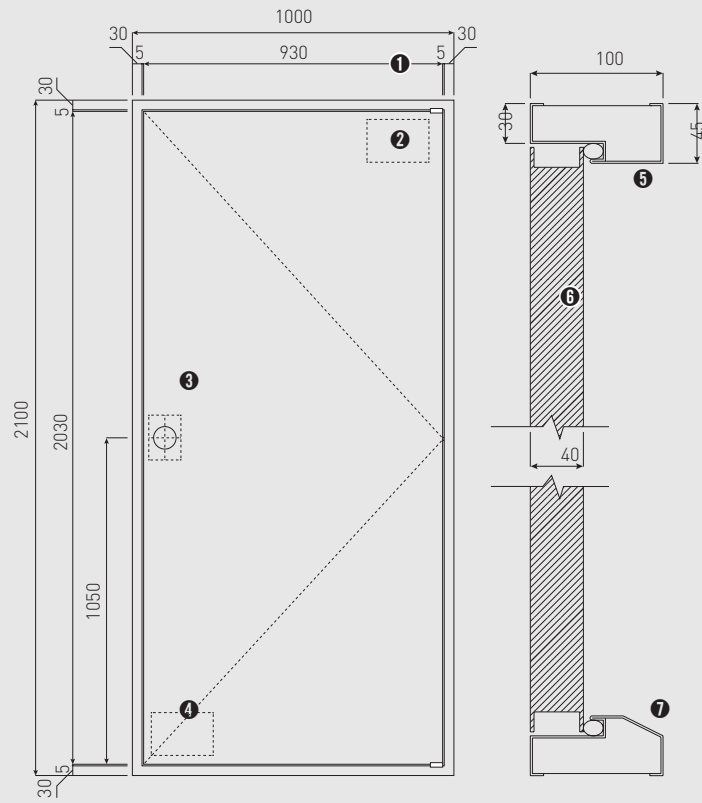

- ① PIVOT HINGE
- ② DOOR CLOSER REINF
- ③ DOOR LOCK & REINF
- ④ DOOR STOPPER REINF
- ⑤ STEEL FRAME
- ⑥ PAPER HONEYCOMB CORE
- ⑦ STAINLESS STEEL FRAME

| 수평 단면 상세도

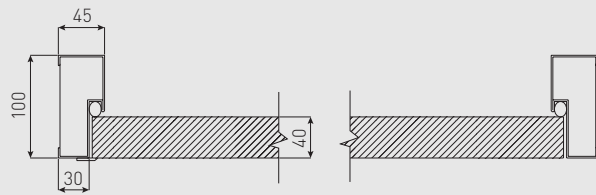

AD 01  
NEW

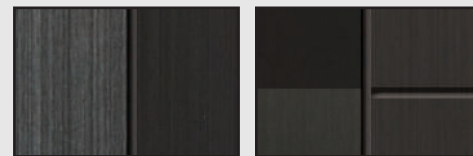

AD 02  
NEW

AD 03  
NEW

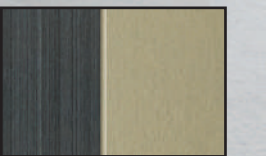
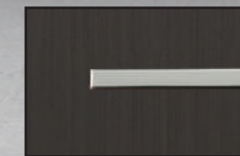

\* 본 카탈로그에 실린 색상은 인쇄된 것이므로 실제 색상과는 다를 수 있습니다.

BEST DESIGN  
HIGH QUALITY DOOR

INTERIOR STEEL DOOR ACE A WILL APPROACH TOWARD THE PUBLIC WITH GOOD DESIGN AND UNIQUE PRODUCT. ACE FIRE DOOR WILL NOT STAY STILL, BUT DEVELOP PERSISTENTLY AND DO ITS BEST. VERY SMALL DIFFERENCES IN THE ATMOSPHERE OF THE HOUSE.



AD 04

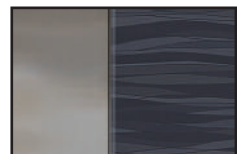

AD 05



AD 06

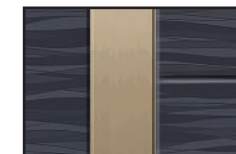

AD 07



\* 본 카탈로그에 실린 색상은 인쇄된 것이므로 실제 색상과는 다를 수 있습니다.

BEST  
DESIGN  
HIGH  
QUALITY  
DOOR



AD 08 **NEW**



AD 09 **NEW**

INTERIOR STEEL DOOR ACE A WILL  
APPROACH TOWARD THE PUBLIC WITH  
GOOD DESIGN AND UNIQUE PRODUCT.  
ACE FIRE DOOR WILL NOT STAY STILL,  
BUT DEVELOP PERSISTENTLY AND DO  
ITS BEST. VERY SMALL DIFFERENCES IN  
THE ATMOSPHERE OF THE HOUSE.



\* 본 카다로그에 실린 색상은 인쇄된 것이므로 실제 색상과는 다를 수 있습니다.



AD 10  
NEW



AD 11 NEW



AD 12 NEW



\* 본 카탈로그에 실린 색상은 인쇄된 것이므로 실제 색상과는 다를 수 있습니다.

AD 13



AD 14



AD 15

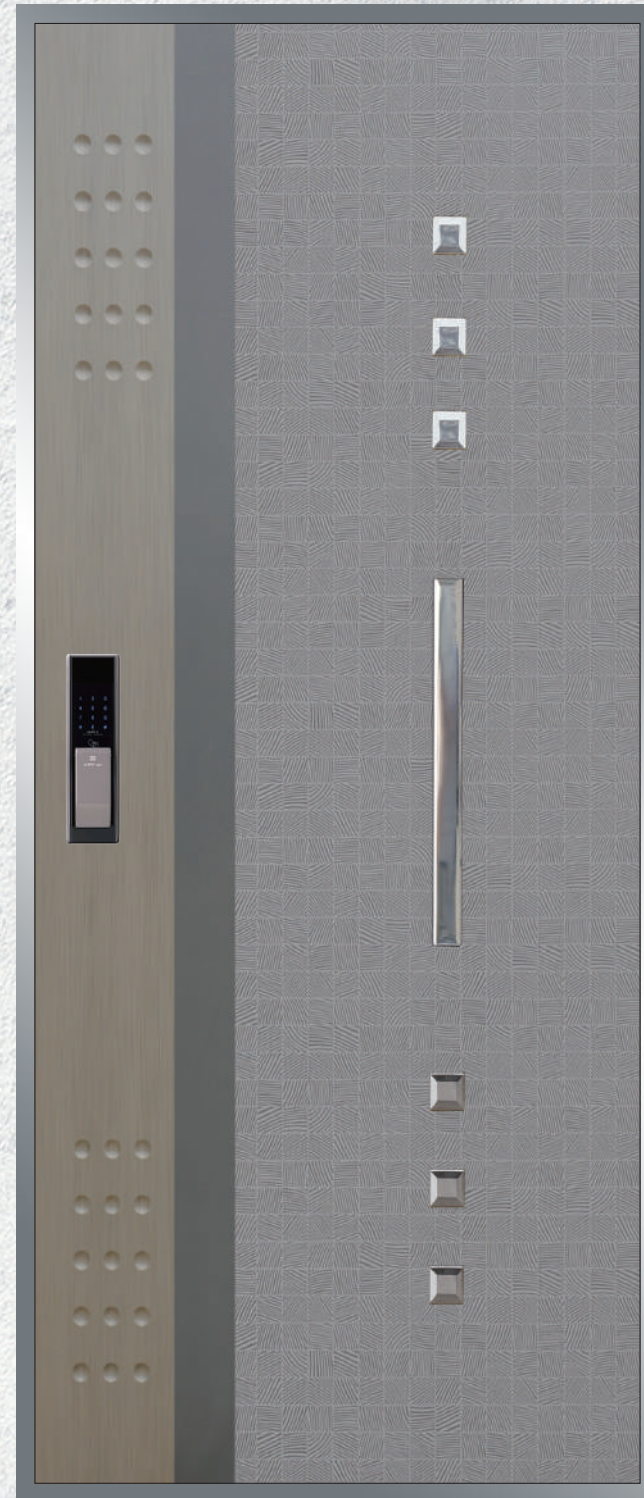

AD 16

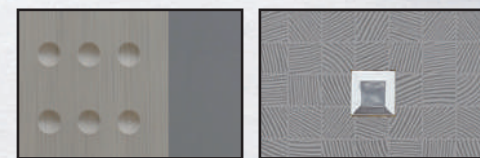
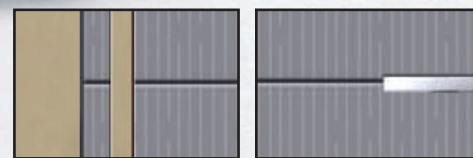
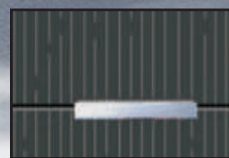

\* 본 카탈로그에 실린 색상은 인쇄된 것이므로 실제 색상과는 다를 수 있습니다.



AD 17  
NEW



AD 18 NEW

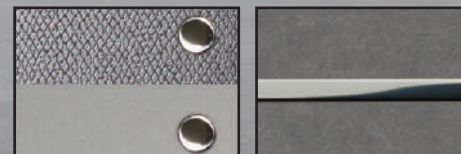

AD 19



\* 본 카탈로그에 실린 색상은 인쇄된 것이므로 실제 색상과는 다를 수 있습니다.

AD 20 **NEW**



AD 21



AD 22

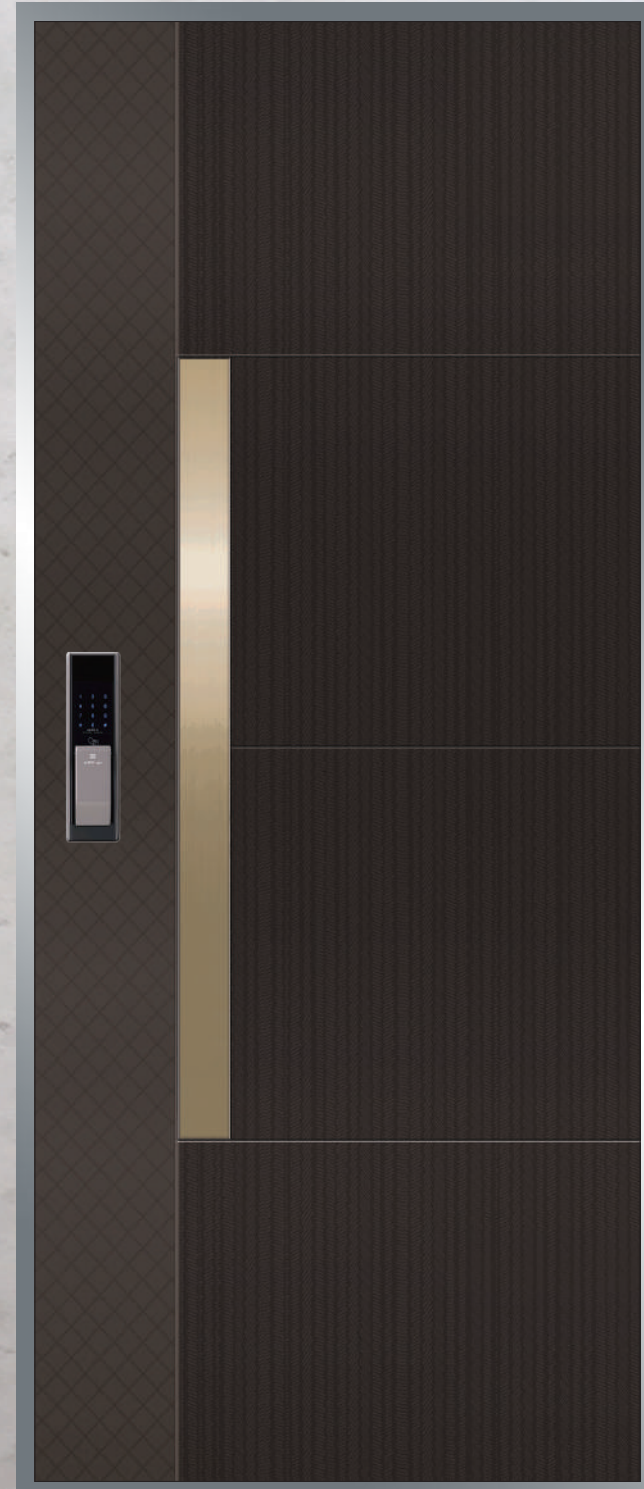

AD 23

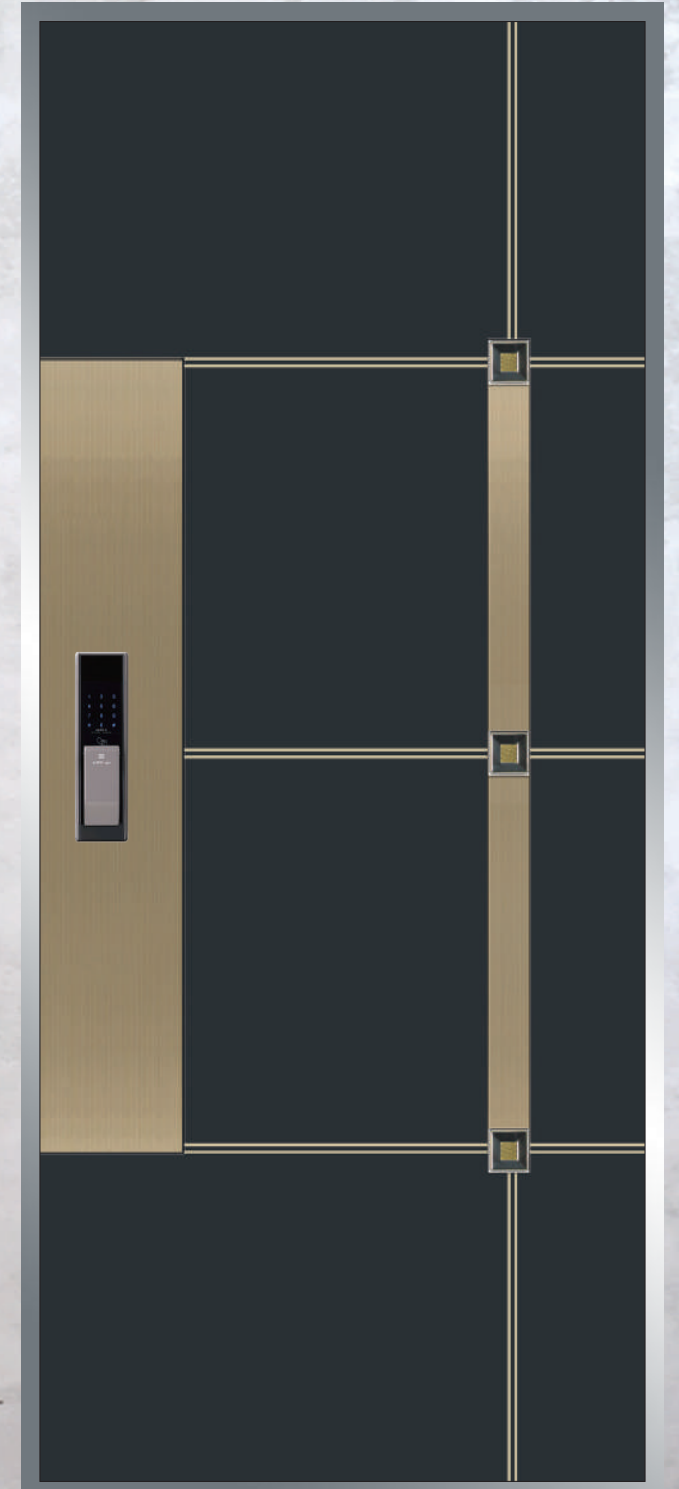

\* 본 카다로그에 실린 색상은 인쇄된 것이므로 실제 색상과는 다를 수 있습니다.



AD 24



AD 25

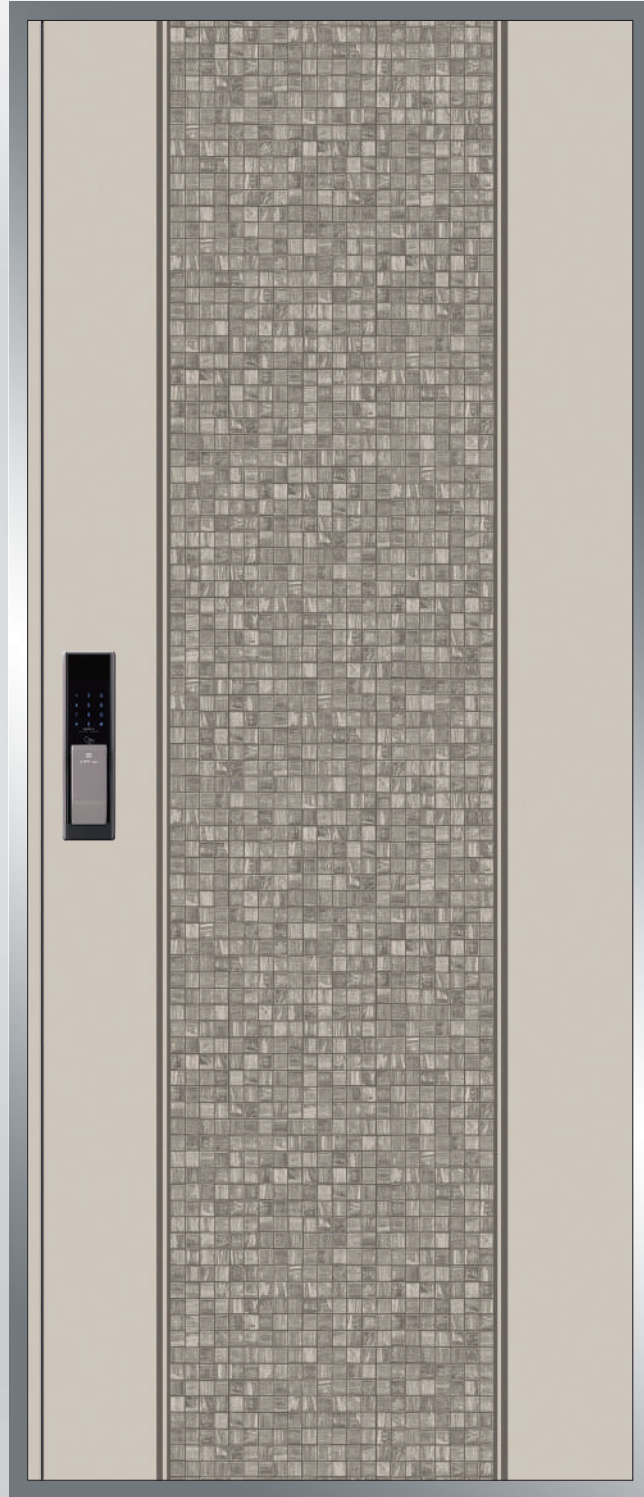

AD 26



AD 27

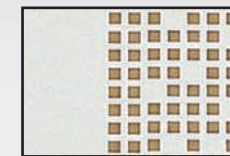

\* 본 카다로그에 실린 색상은 인쇄된 것이므로 실제 색상과는 다를 수 있습니다.



CHM 06 **NEW**

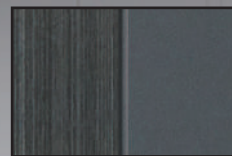

\* 분체도장도어는 색상변경이 가능한 도어입니다.

CHM 08

CHM 01

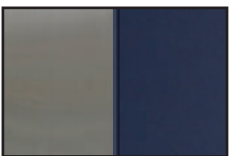
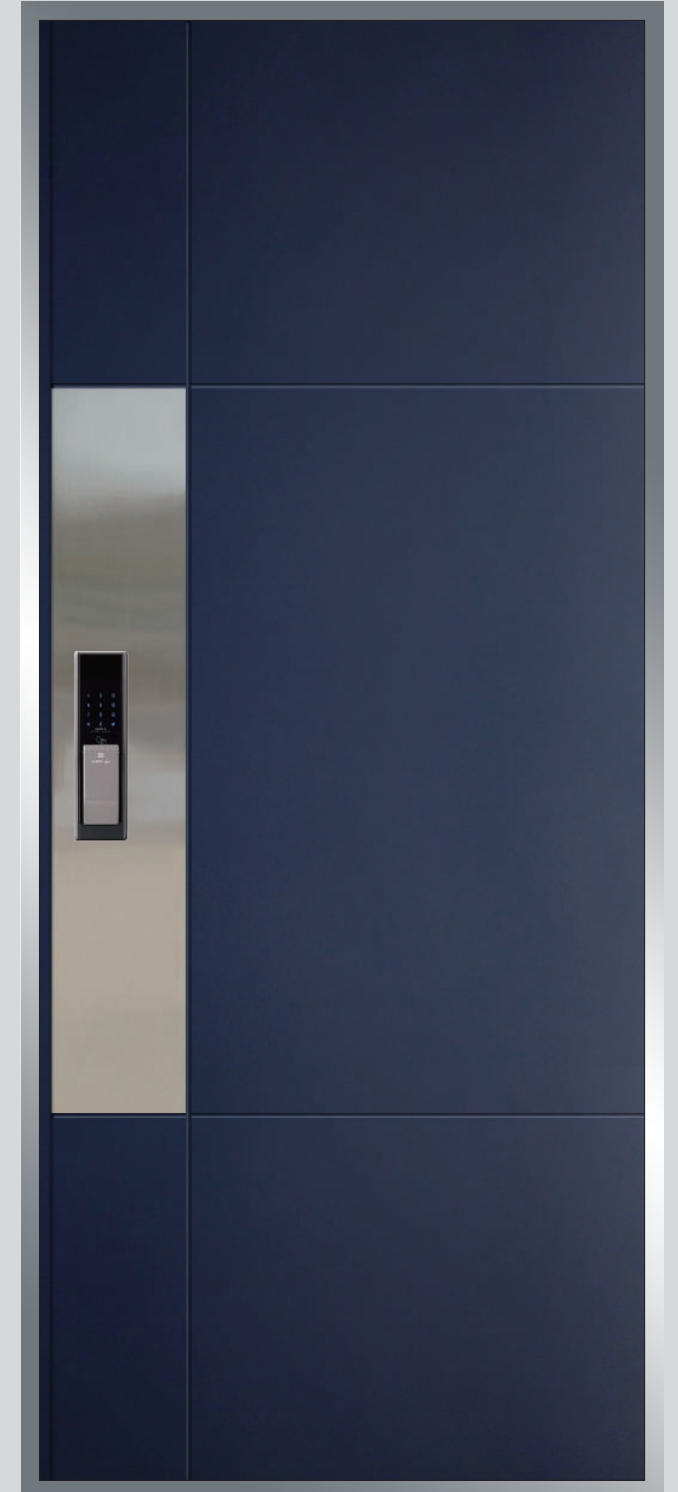
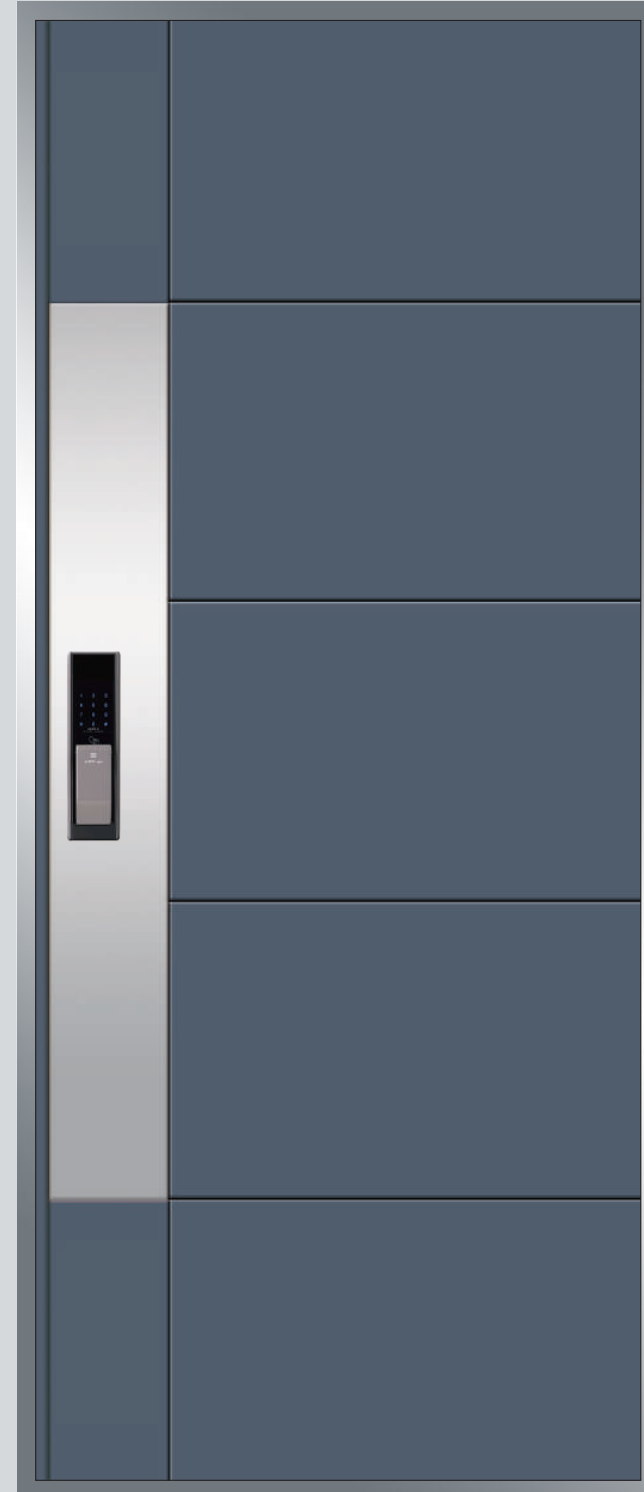

\* 본 카다로그에 실린 색상은 인쇄된 것이므로 실제 색상과는 다를 수 있습니다.

# THE CHARM OF LUXURY.

심플하면서 도시적인 감성이 가득한 디자인. 한눈에 시선을 강렬하게 사로잡는 현대인들의 감성을 잘 반영한 도어입니다.

CHM 03



CHM 02



CHM 07 **NEW**

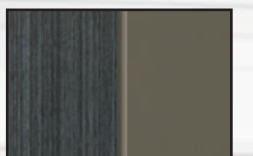

\* 분체도장도어는 색상변경이 가능한 도어입니다.

\* 본 카다로그에 실린 색상은 인쇄된 것이므로 실제 색상과는 다를 수 있습니다.

CHM 09

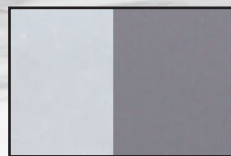

CHM 10



CHM 11

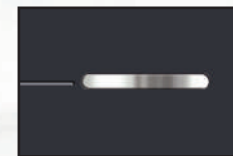

CHM 12



\* 분체도장도어는 색상변경이 가능한 도어입니다.

\* 본 카다로그에 실린 색상은 인쇄된 것이므로 실제 색상과는 다를 수 있습니다.

ACE 01

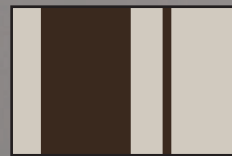

어느 공간에서도 잘 어울리는 도어,  
깨끗한 색상에 선과 면이 어우러진  
고품격 디자인 도어입니다.

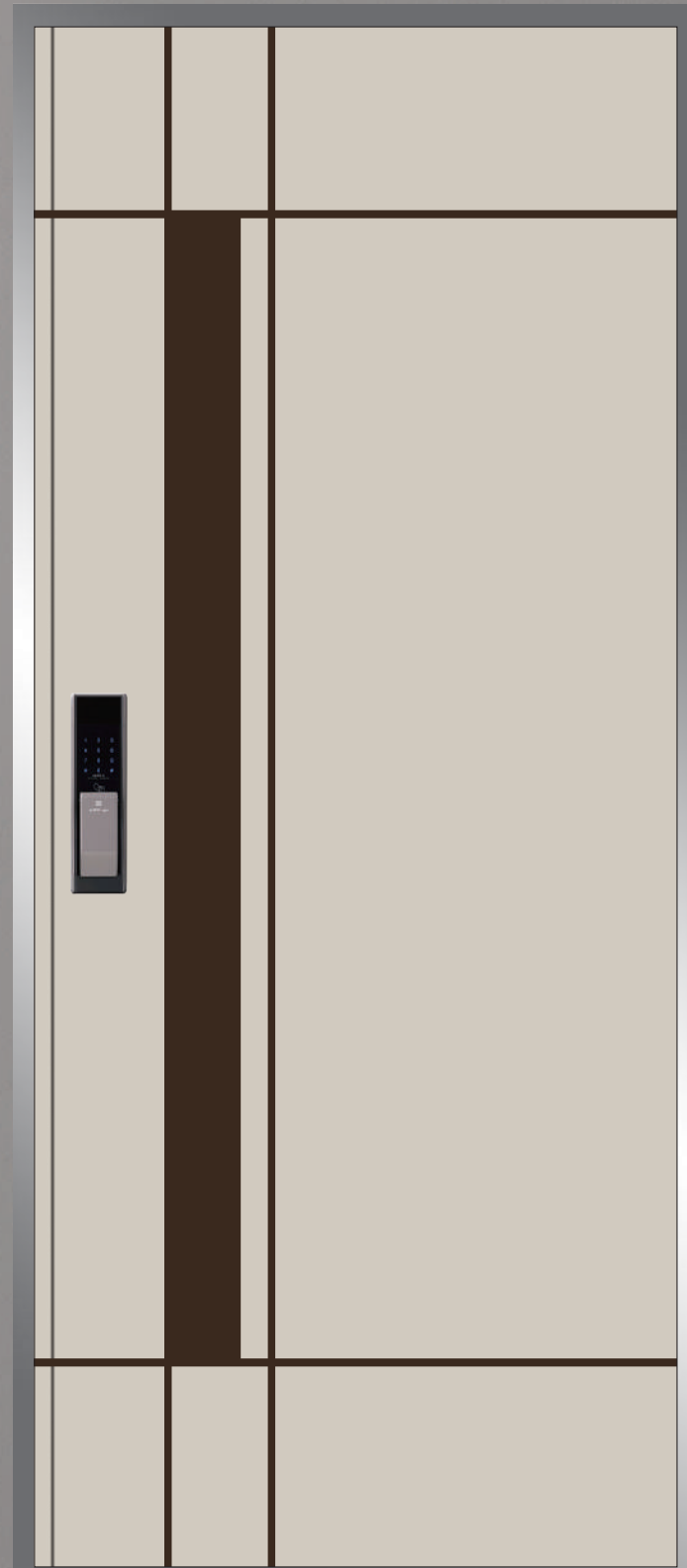

ACE 02

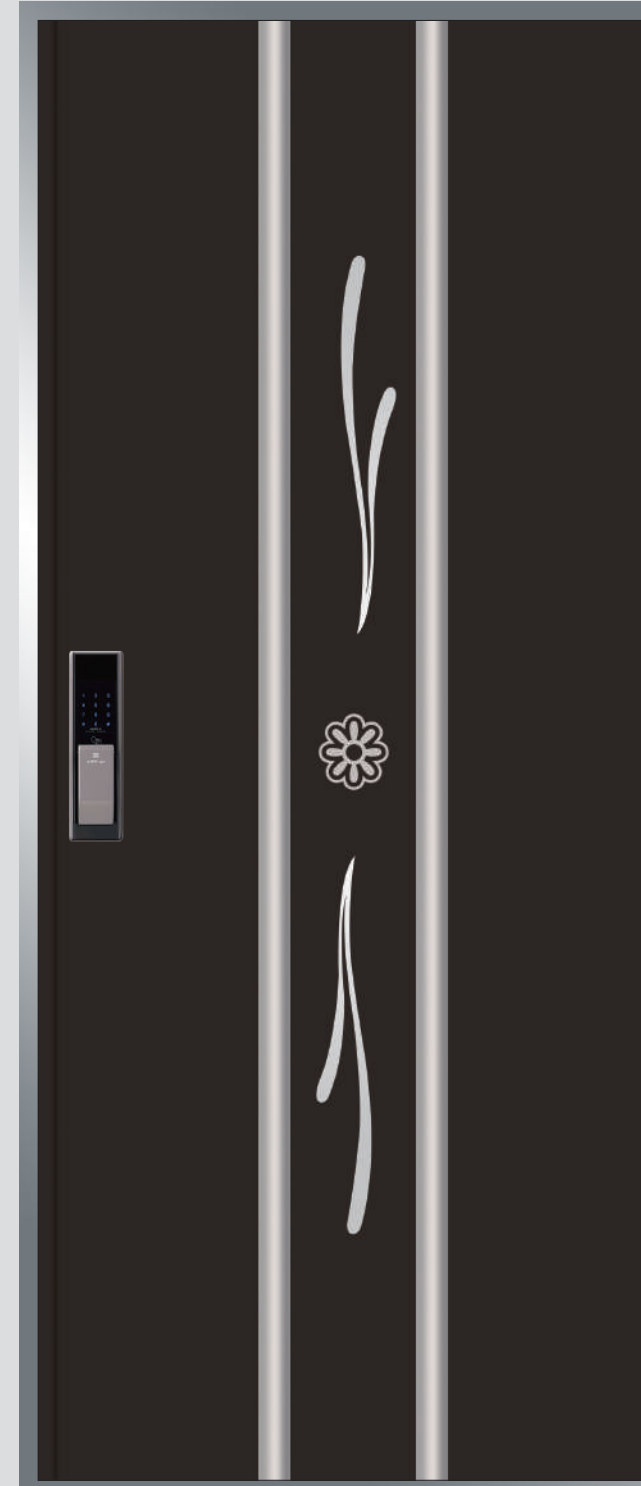

ACE 03

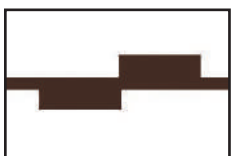
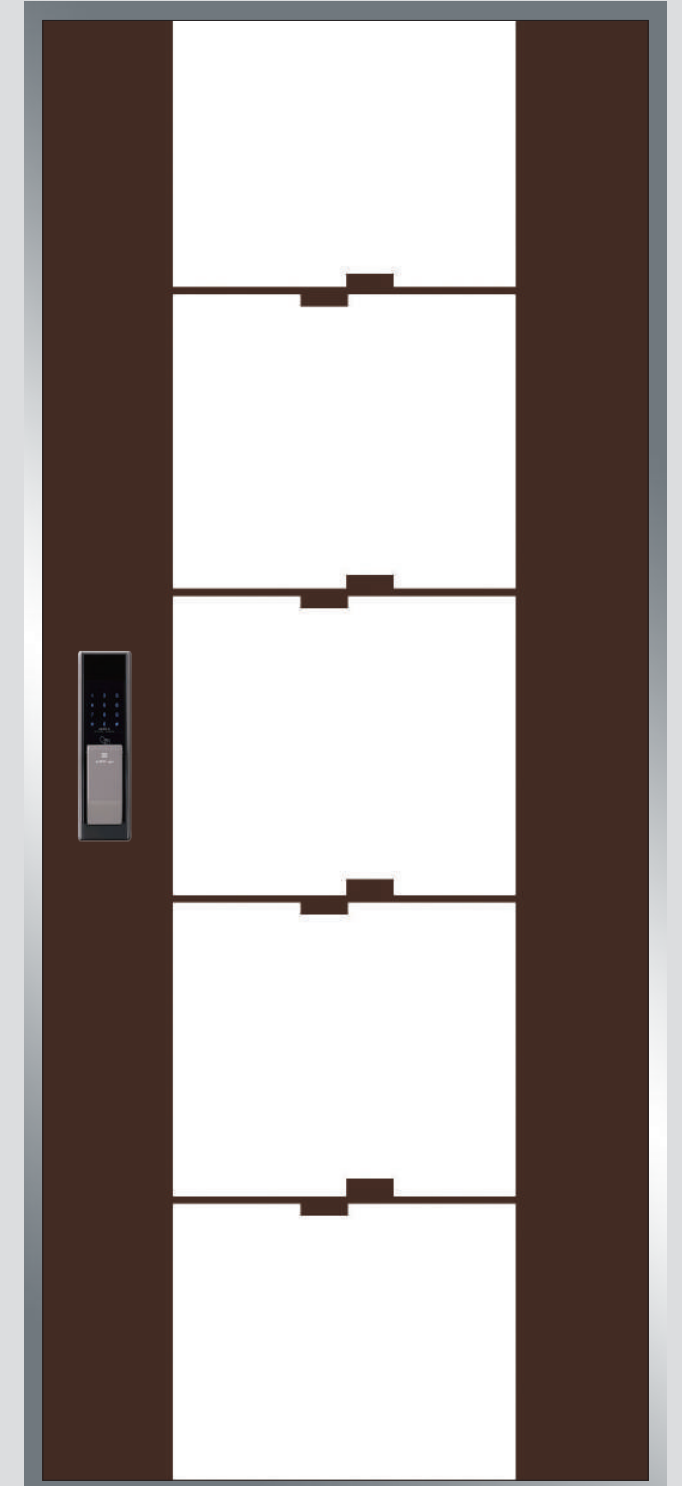

\* 본 카다로그에 실린 색상은 인쇄된 것이므로 실제 색상과는 다를 수 있습니다.

ACE 04

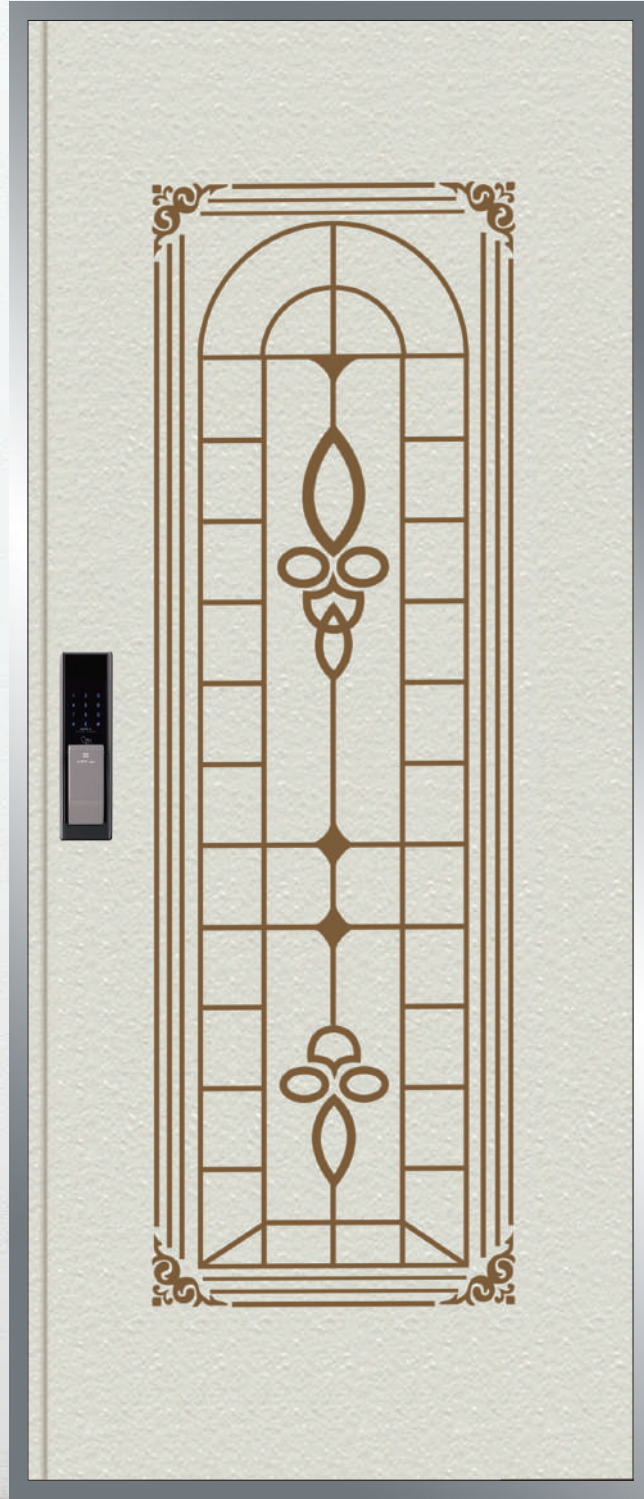

ACE 05

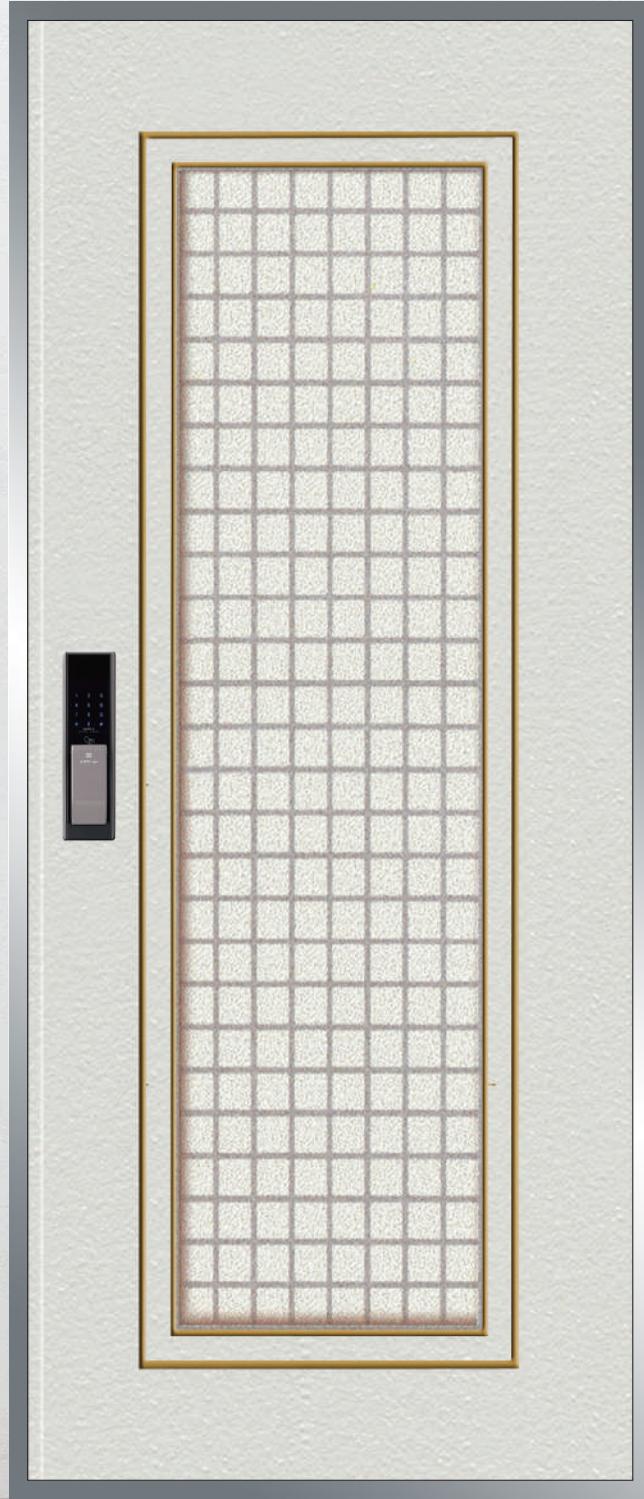

ACE 06

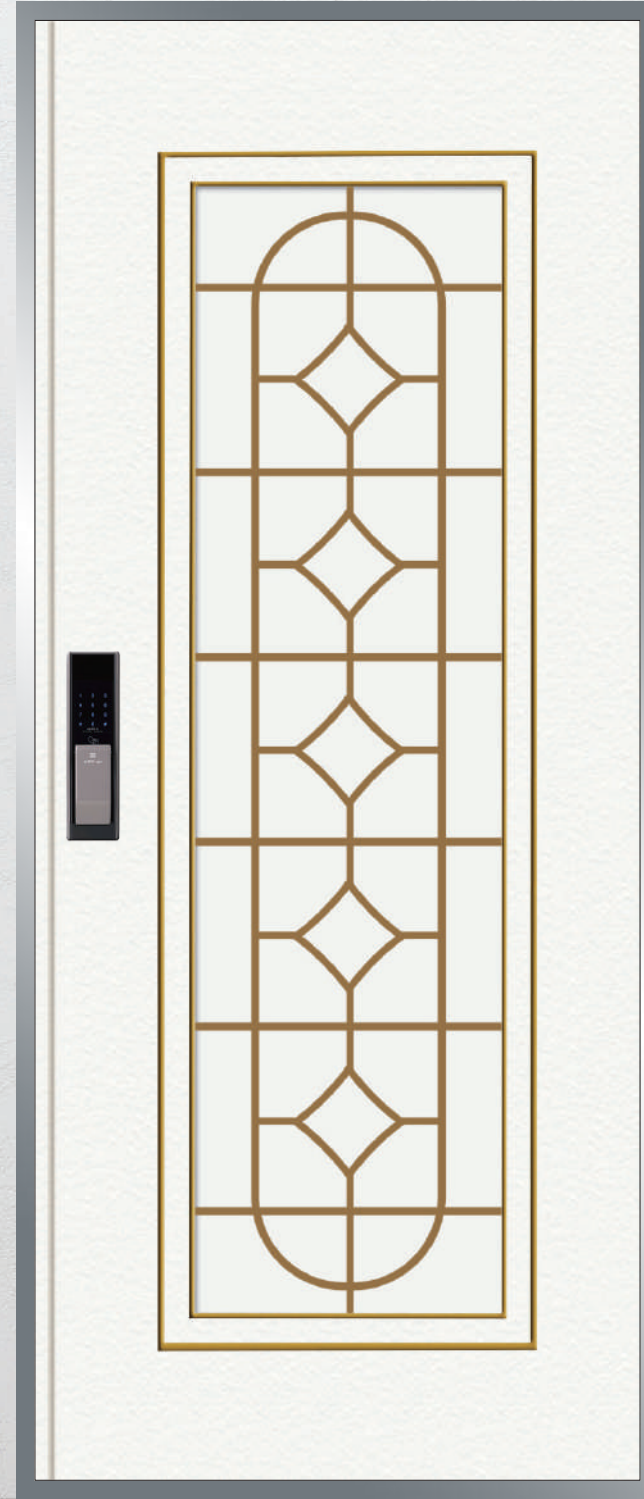

ACE 07

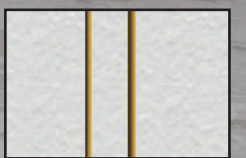
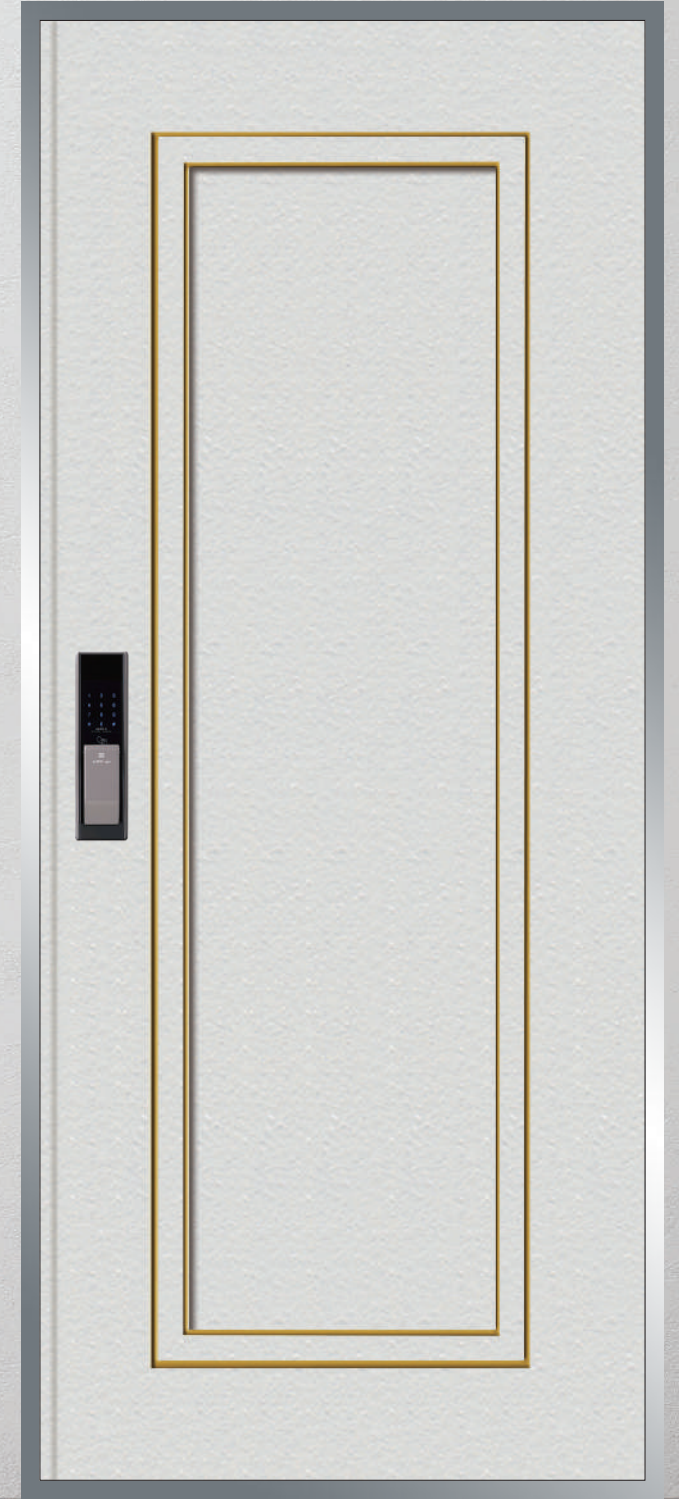

\* 본 카탈로그에 실린 색상은 인쇄된 것이므로 실제 색상과는 다를 수 있습니다.

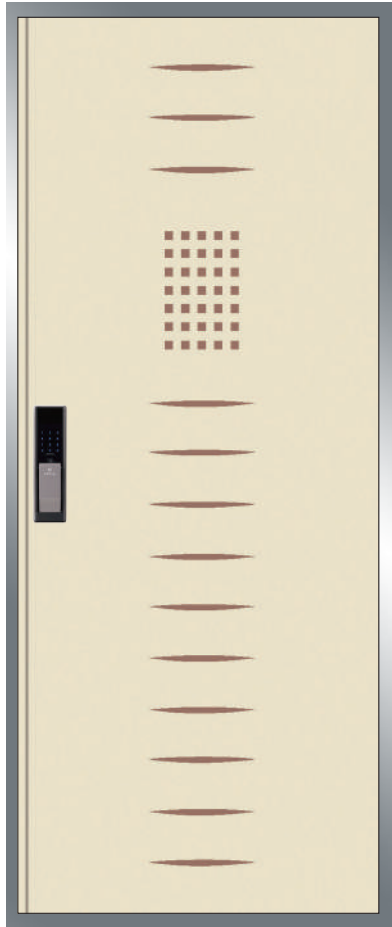

ACE 08

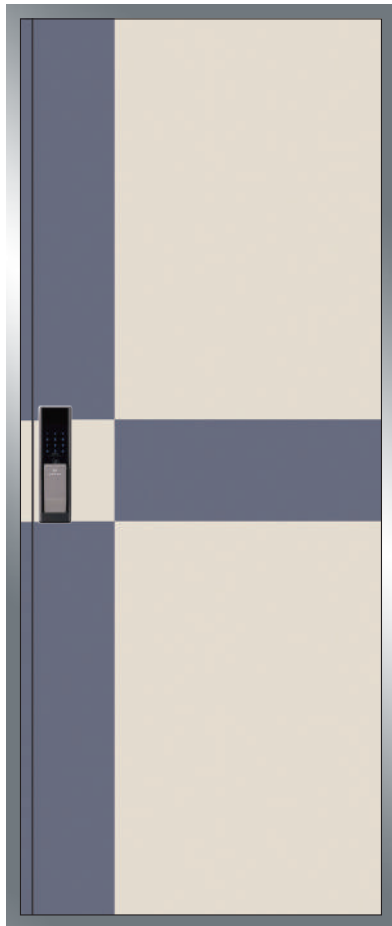

ACE 09

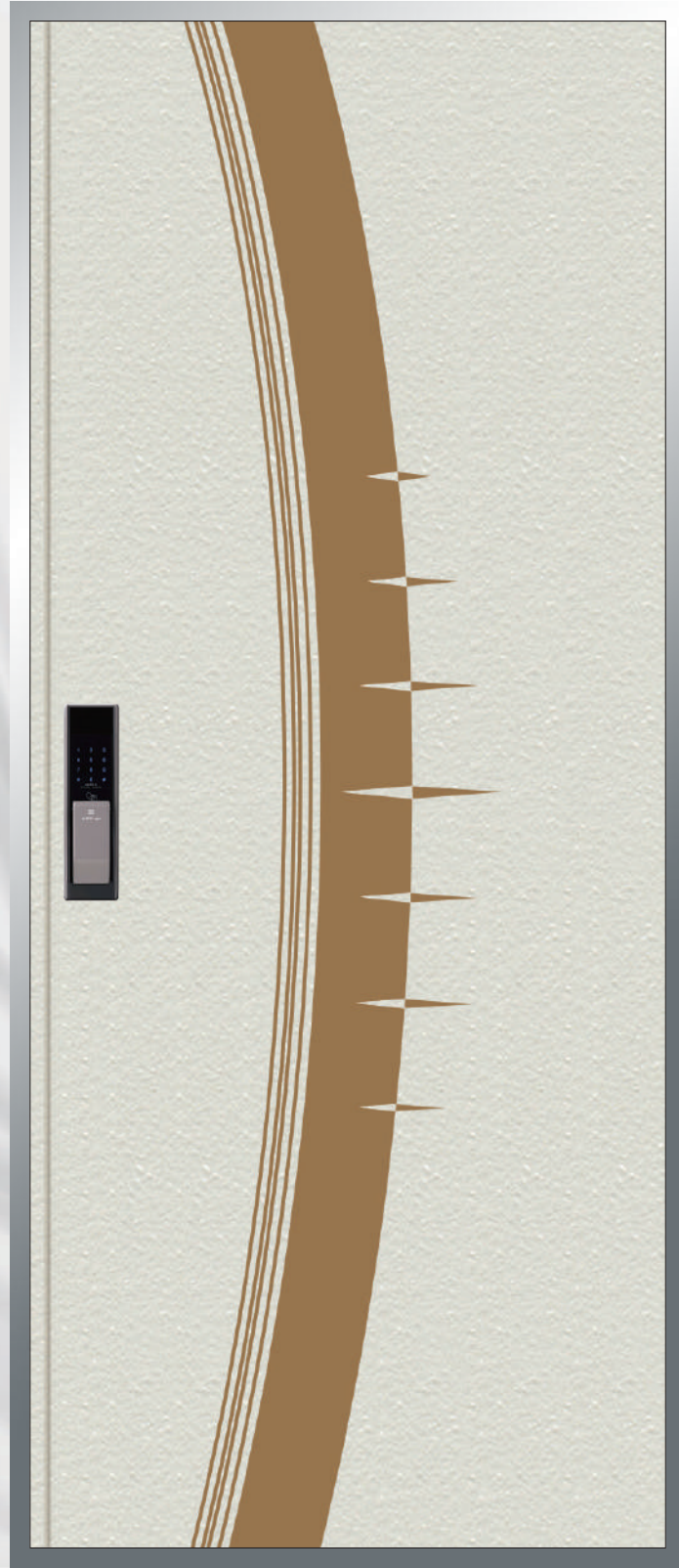

ACE 10

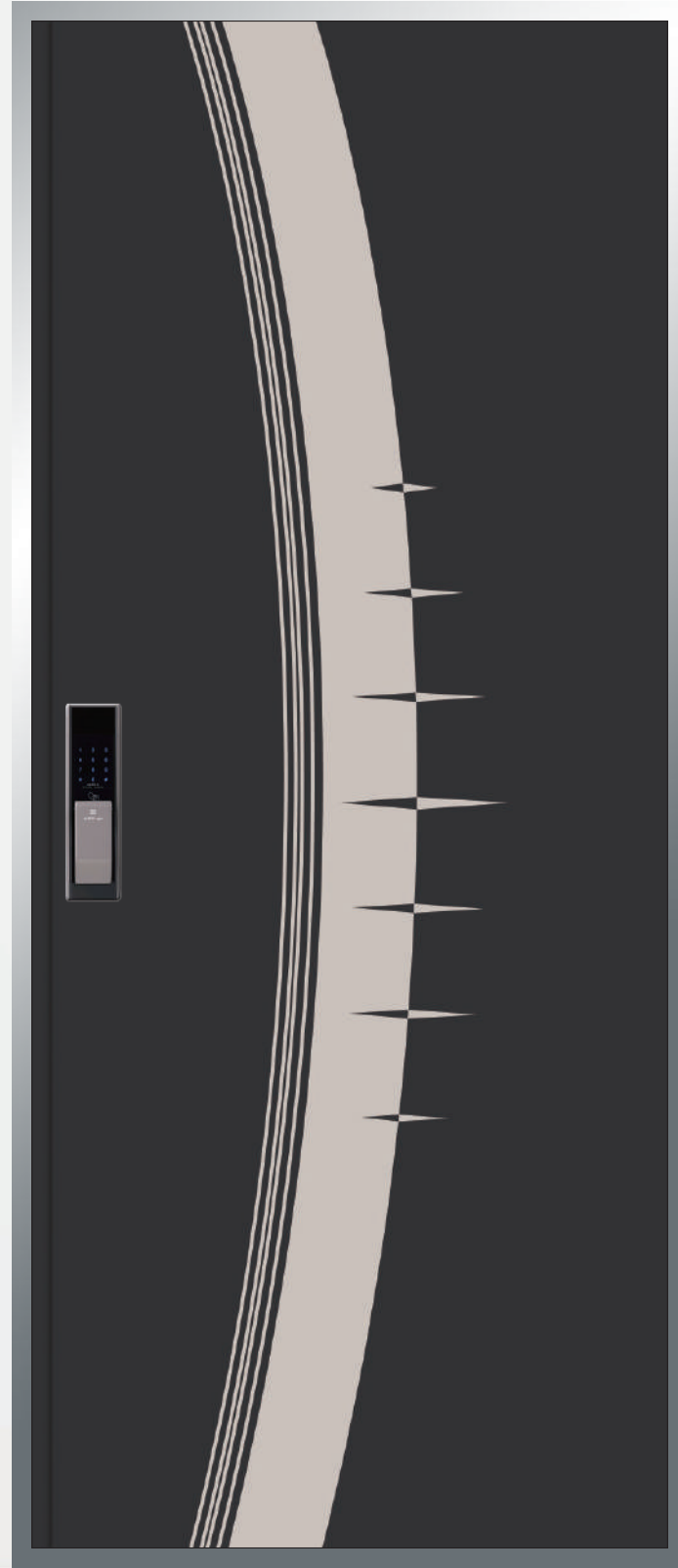

ACE 11

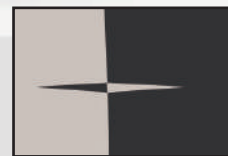

ACE 12



ACE 13

\* 본 카탈로그에 실린 색상은 인쇄된 것이므로 실제 색상과는 다를 수 있습니다.

방음문 A형

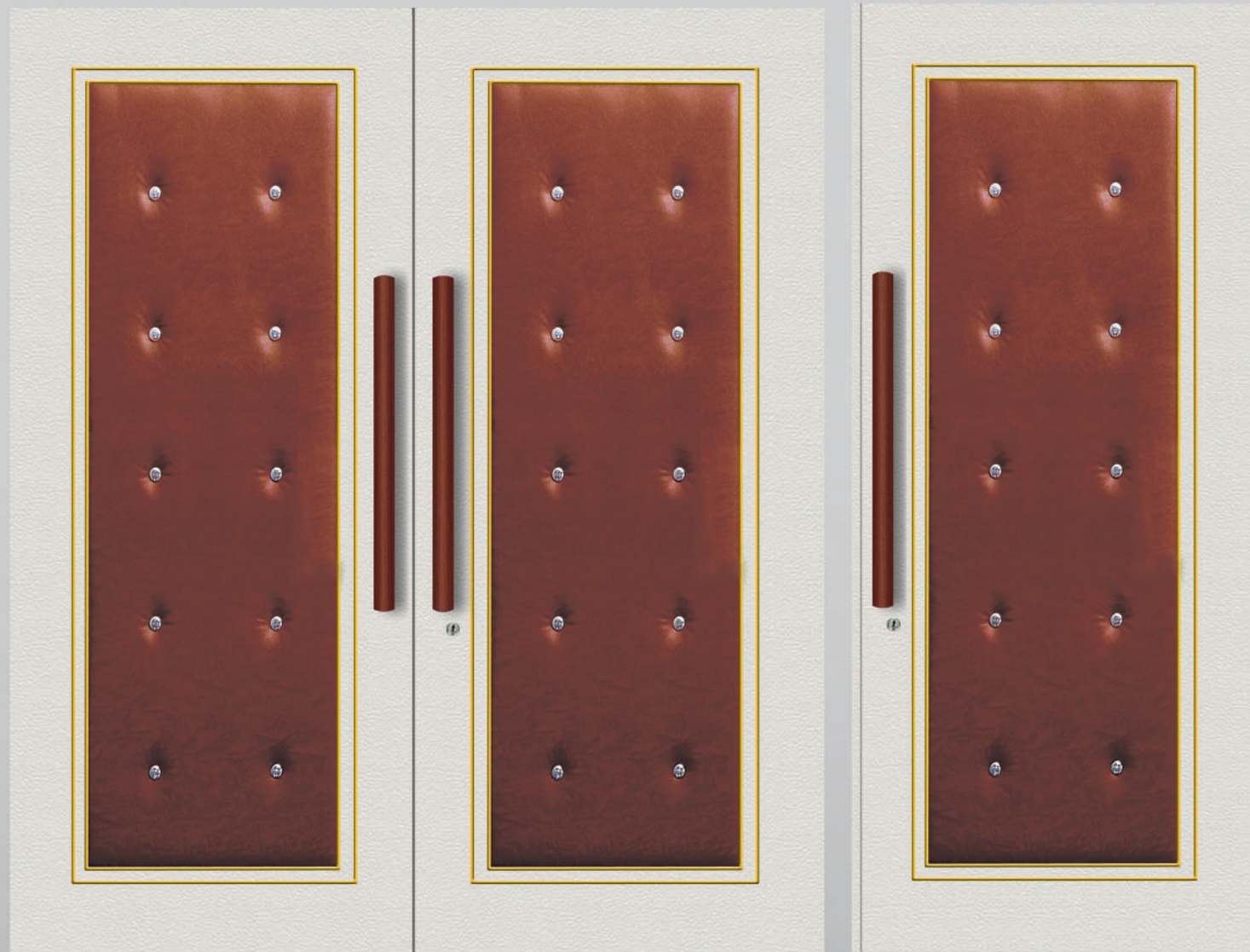

(W)1800 × (H)2100 × (T)80 mm

(W)900 × (H)2100 × (T)80 mm /  
(W)1000 × (H)2100 × (T)80 mm

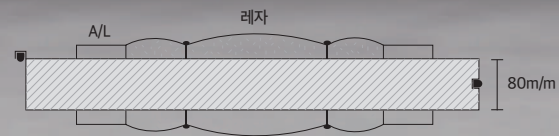

슬라이딩도어(반자동)

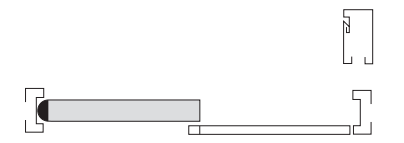

슬라이딩도어(반자동)

\* 본 카다로그에 실린 색상은 인쇄된 것이므로 실제 색상과는 다를 수 있습니다.



# ACE FIRE DOOR [매립도어제작]

# [상세도면]



편개 90°

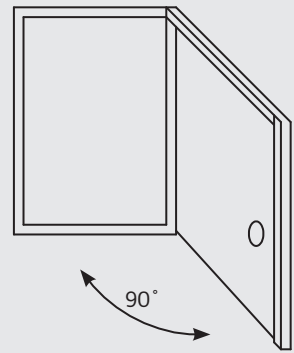

양개 90°

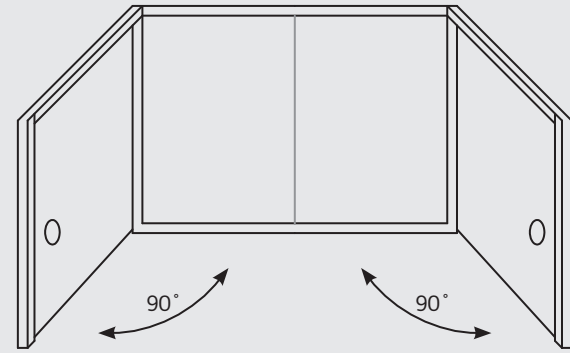

예1) 우힌지 편개 90° 열리는 문

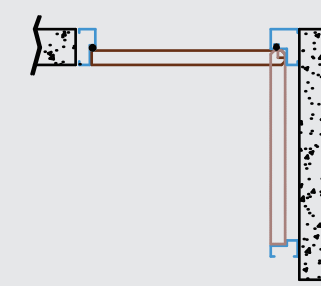

예2) 우힌지 편개 180° 열리는 문

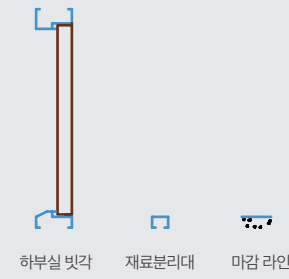
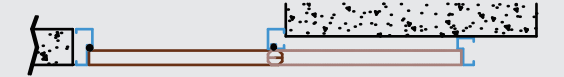

편개 180°

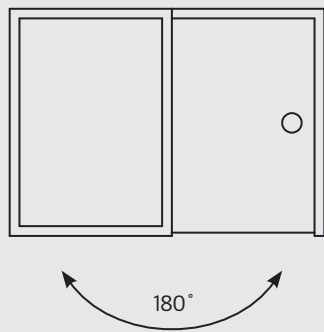

양개 180°

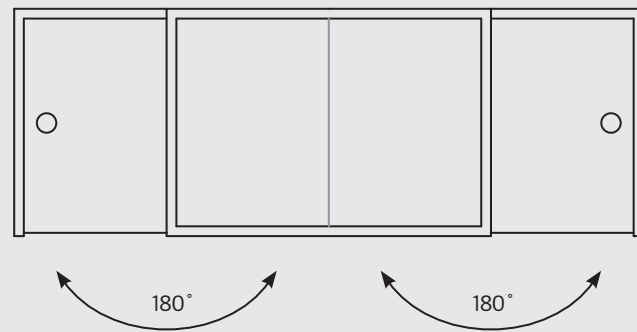

예3) 양개 90° 열리는 문

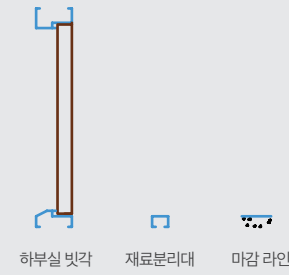
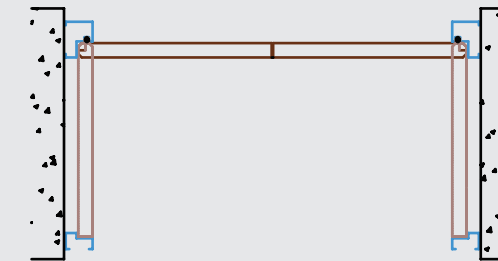

예4) 양개 180° 열리는 문



양개 90°, 양개 180°

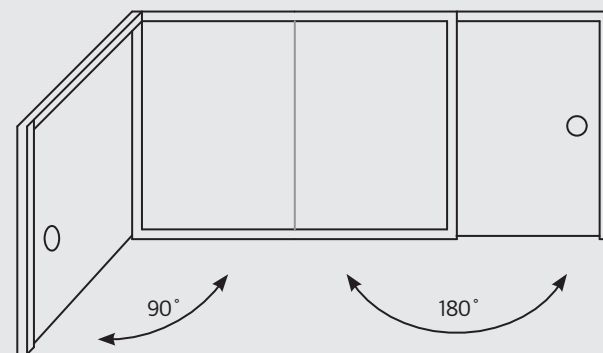

예5) 양개 좌 90°, 우 180° 열리는 문

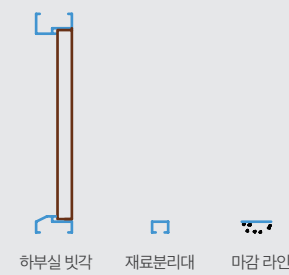
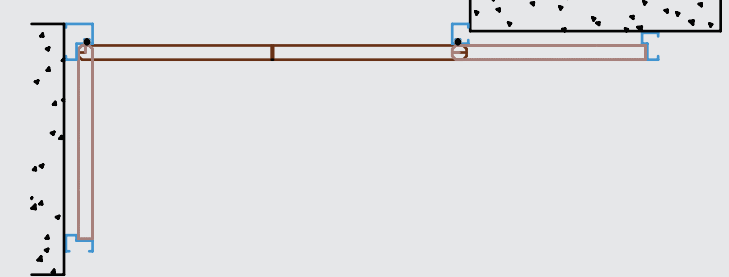

\* 본 카다로그에 실린 색상은 인쇄된 것이므로 실제 색상과는 다를 수 있습니다.

[ 타공종류-프레임단면도 ]

프레임 제작 가능 [소대, 남마] / 철판 마감 / 유리마감

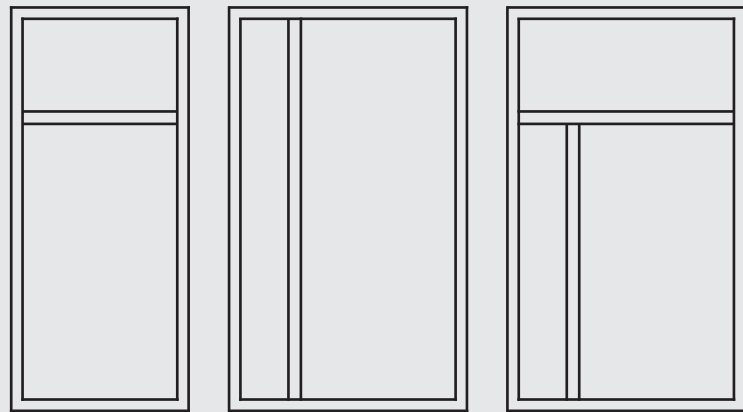

(유리별도)

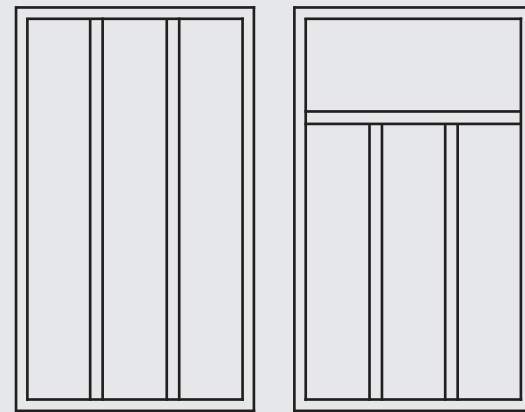

도어 타공

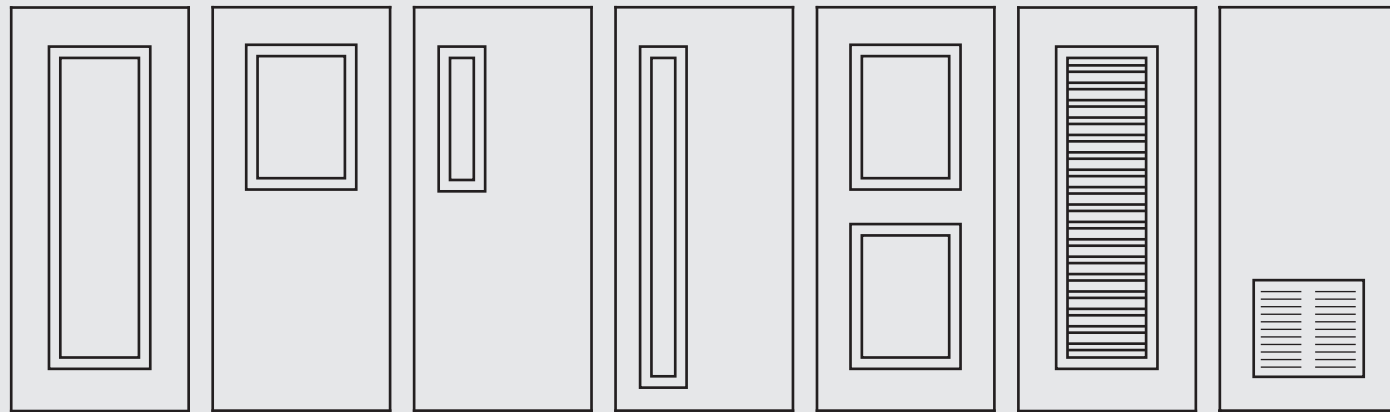

(유리타공)

(갤러리타공)

(NCT루버타공)

프레임단면도

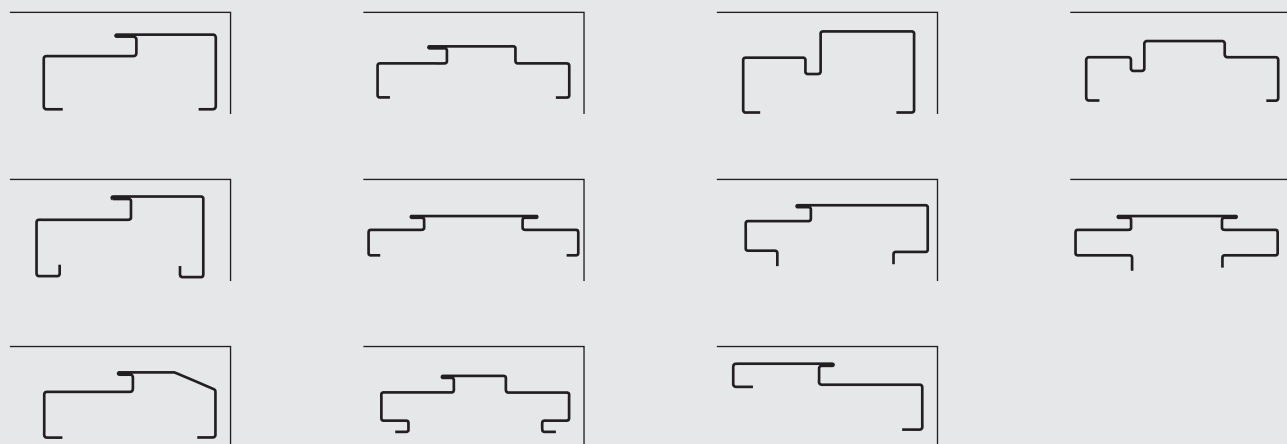

[ COLOR-삼화페인트 ]

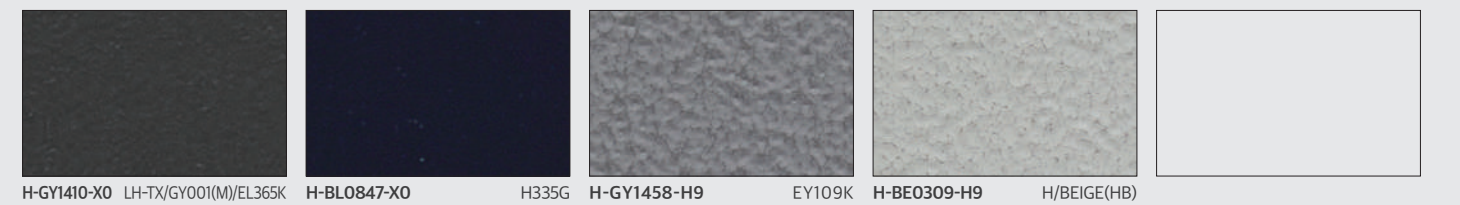
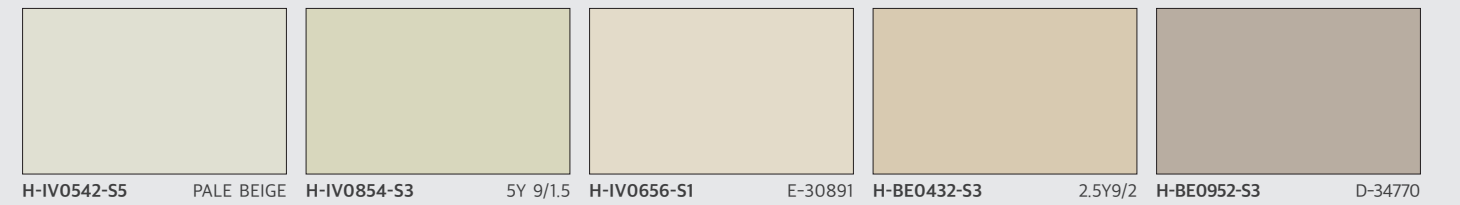

\* 본 카탈로그에 실린 색상은 인쇄된 것이므로 실제 색상과는 다를 수 있습니다.

[ (주)천문 | 에이스산업 : 샤링사업부 ]

각종 자재  
(갈바/스텐 0.5t~3.2t)  
절단, 절곡 전문!!

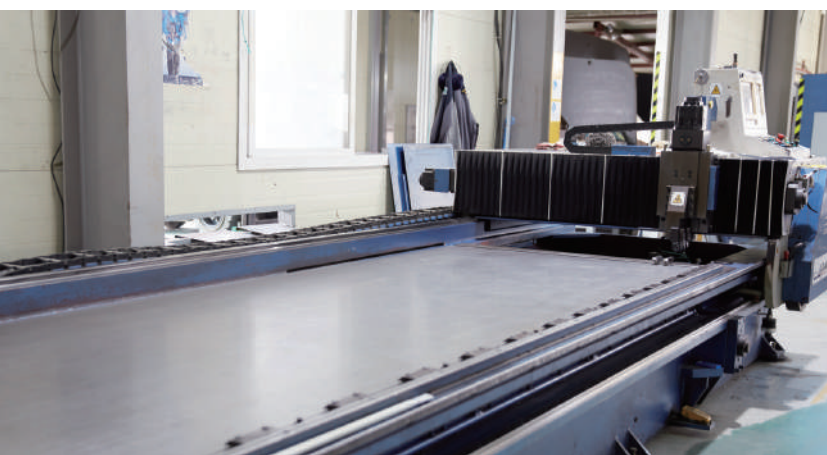
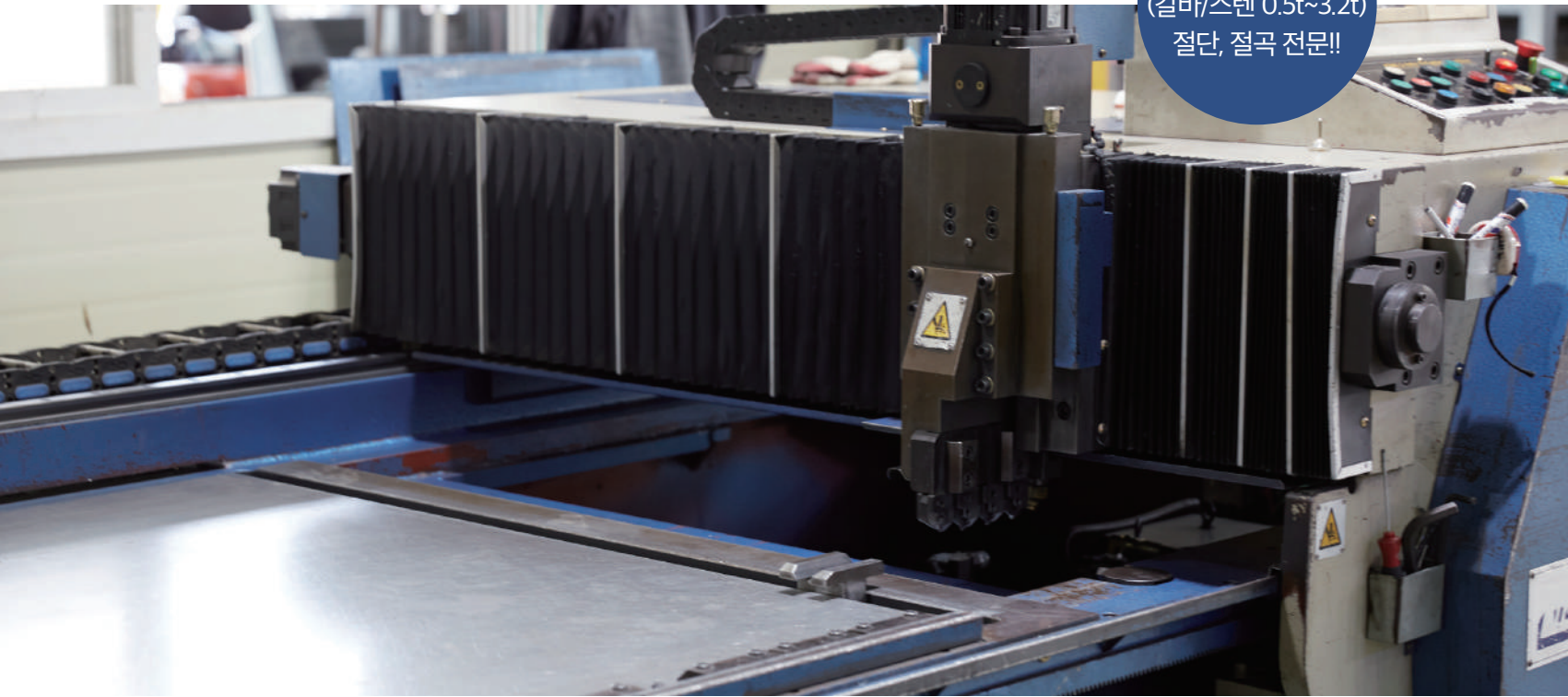

\*\*\* 신속 정확한 작업으로, 납기 준수를 철저히 하겠습니다.

[ 단열바, 생산전문 ]  
가마씨도어

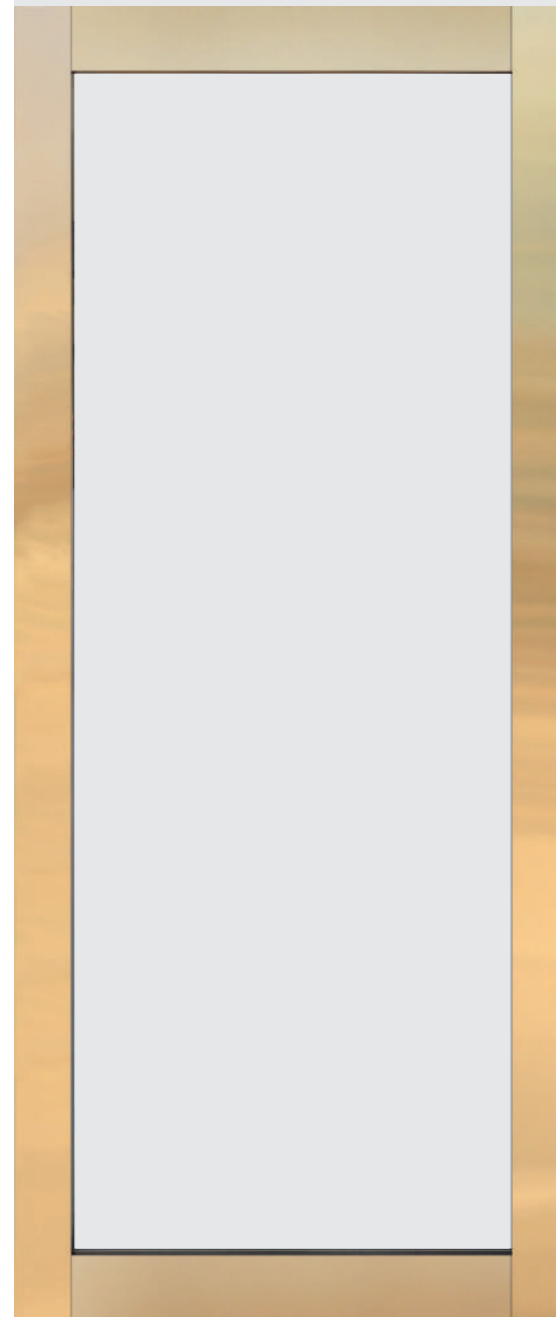

절곡유형

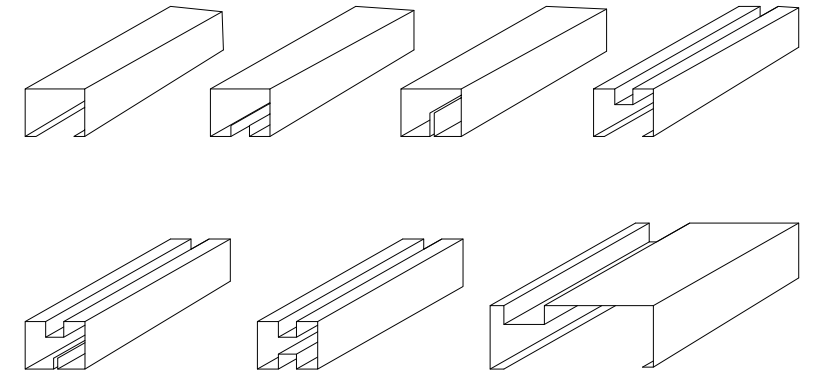

용도별 절곡유형

1) 샷레일바

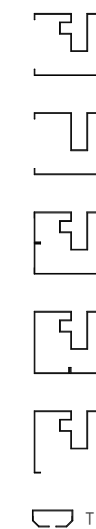

2) 강화도어 FRAME

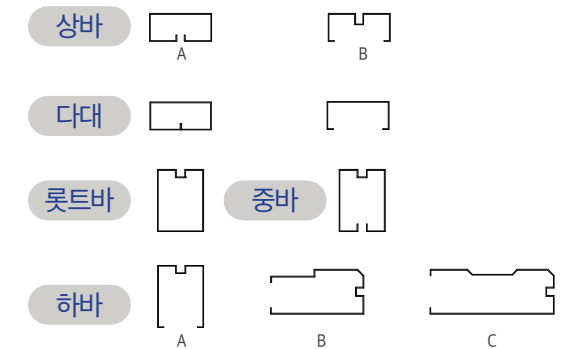

3) 코너바

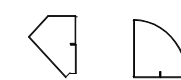

4) 코너비트



강화도어 FRAME

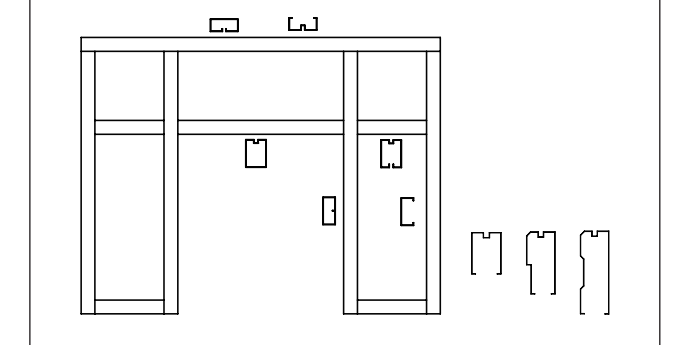

\* 본 카다로그에 실린 색상은 인쇄된 것이므로 실제 색상과는 다를 수 있습니다.

[ 문턱없는 방화문 ]



방화문의 문턱으로 인해 발생하는 불편함을 해결하기 위해 문턱을 없애고 하부에는 자동 승강식 폐쇄장치로 완전 밀폐되는 구조로 개발!!



방화문 도면

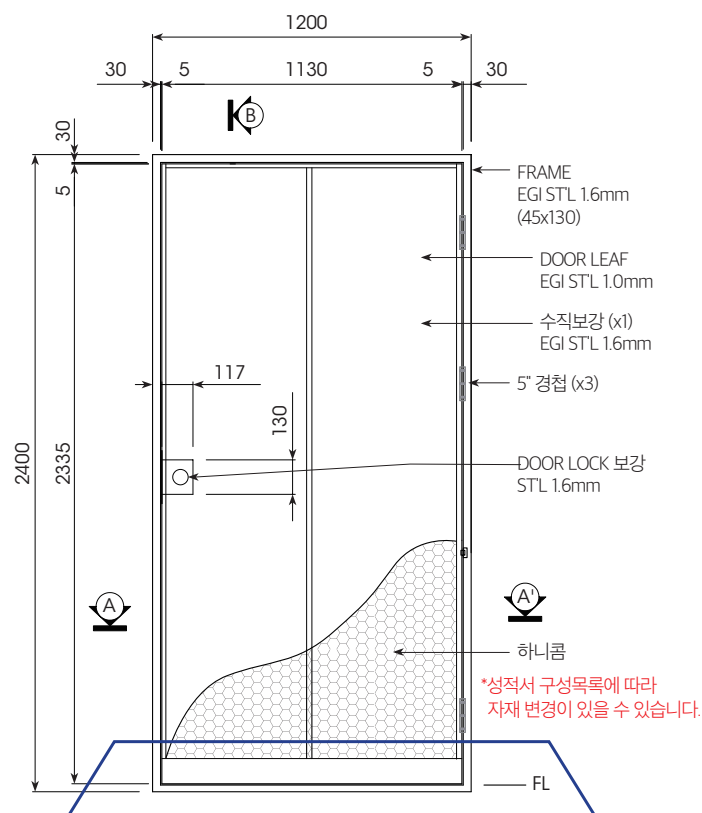

방화문턱의 차폐 원리

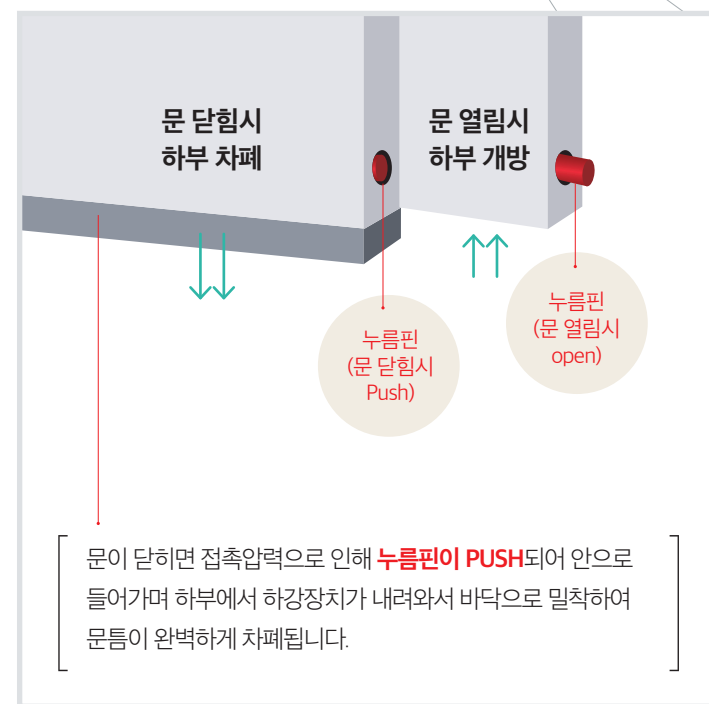

ACE FIRE DOOR 제휴업체 한솔이엔지

고객의 편리하고 더 나은 삶을 위하여 (주)천문 | 에이스산업



취급품목



주소 : 경기도 평택시 고덕면 청원로 732-4  
TEL : (031) 668-6693 FAX : (031) 611-6693

\* 본 카다로그에 실린 색상은 인쇄된 것이므로 실제 색상과는 다를 수 있습니다.